

560, 563

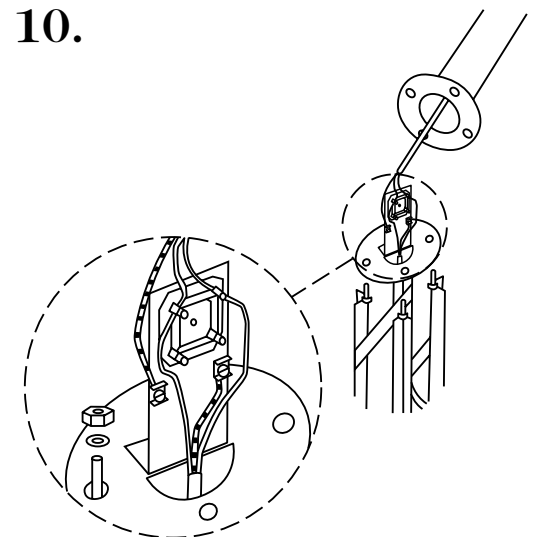
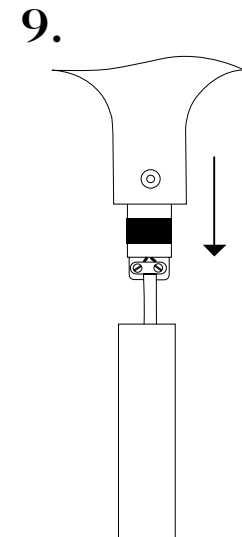
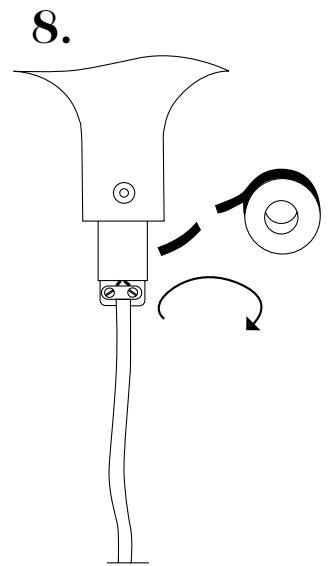
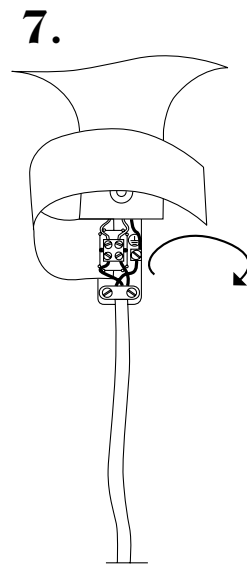
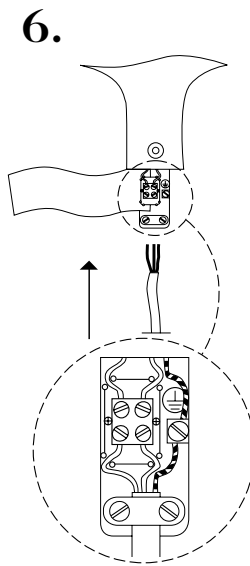
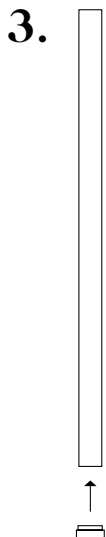
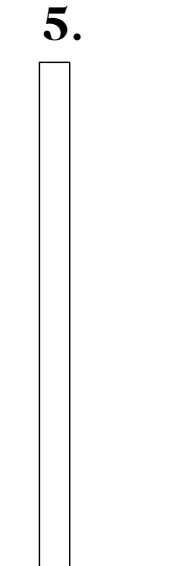
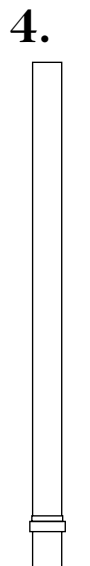
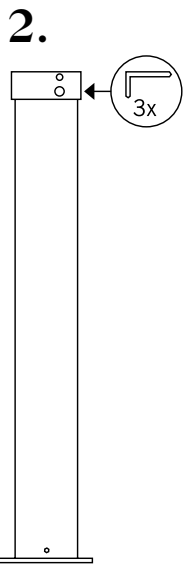
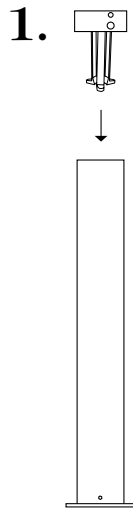
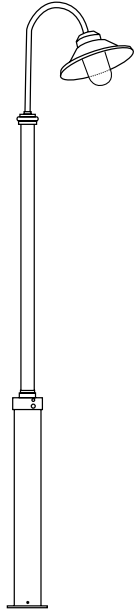

SE - Monteringsanvisning Stolplykta. Får endast installeras av behörig elektriker.

DE - Aufbauanleitung Mastleuchte. Die Leuchte ist von einem qualifizierten Elektriker zu installieren.

GB - Installation instructions Pole Lamp. The light fitting must be installed by a qualified electrician.

FR - Instructions de montage pour Lampadaire. L'armature doit être installée par un électricien professionnel.

FI - Valaisinpylvään asennusohjeet. Valaisimen saa asentaa vain ammattitaitoinen sähkömies.

NL - Montagevoorschrift lantaarnlamp. Het armatuur moet geïnstalleerd worden door een erkend elektricien.

DK - Monteringsvejledning til standerlampe. Armaturet skal installeres af en autoriseret elektriker.

NO - Monteringsanvisning stolpelykt. Kan kun monteres av autorisert installatør.

PL - Instrukcja montażu lampy stojącej. Instalacja powinna być wykonana przez kwalifikowanego elektryka.

ES - Instrucciones de instalación de Lámpara de Poste. La instalación tiene que hacerse por un electricista.

IT - Istruzioni d'installazione della lampada a palo. L'installazione va fatta da un elettricista specializzato.

CZ - Instalační pokyny pro stojanové svítidlo. Smí být instalováno pouze elektrikářem.