



Pro Weather Station Model: WMR86 / WMR86A

USER MANUAL

CONTENTS

- Introduction..... 1
- Packaging Contents 1
 - Base Station 1
 - Wind Sensor 1
 - Temperature & Humidity Sensor..... 1
 - Rain Gauge..... 2
- Accessories - Sensors 2
- Overview..... 2
 - Front View..... 2
 - Back View 2
 - LCD Display..... 2
 - Wind Sensor 3
 - Rain Gauge..... 3
 - Outdoor Temperature / Humidity Sensor 4
- Getting Started..... 4
 - Set Up Remote Wind Sensor..... 4
 - Set Up Remote Temperature / Humidity Sensor.. 4
 - Set Up Rain Gauge..... 4
 - Set Up Base Station 4
- Verify Connection..... 5
 - Wind Sensor 5
 - Temperature / Humidity Sensor 5
 - Rain Gauge..... 5
- Mounting / Placing Of Sensors 5
 - Wind Sensor 5
 - Temperature / Humidity Sensor 6
 - Rain Gauge..... 6
- Clock Reception 6
- Clock / Calendar 7
- Moon Phase 7
- Auto Scanning Function 7
- Weather Forecast 7
- Temperature And Humidity..... 7
 - Temperature And Humidity Trend 8
- Wind Chill / Direction / Speed..... 8
- Uvi / Barometer / Rainfall..... 8
 - UV Index..... 9
 - Barometer 9
 - Rainfall..... 9
- Backlight 9
- Reset..... 9
- Specifications 9
- About Oregon Scientific 10
- EU Declaration Of Conformity..... 11
- FCC statement 11

INTRODUCTION

Thank you for selecting the Oregon Scientific™ Weather Station (WMR86 / WMR86A).

The base station is compatible with other sensors. To purchase additional sensors, please contact your local retailer.



Sensors with this logo 3.0 are compatible with this unit.

NOTE Please keep this manual handy as you use your new product. It contains practical step-by-step instructions, as well as technical specifications and warnings you should know about.

PACKAGING CONTENTS

BASE STATION



1 x Base Station



3 x AA UM-3
1.5V batteries

WIND SENSOR



1 x Wind Sensor (1
x Wind Vane Above
and 1 x Anemometer
Below)



1 x sensor
connector



2 x AA UM-3
1.5V batteries



4 x Screws
(Type A)



1 x Round
U- bolt

TEMPERATURE & HUMIDITY SENSOR



1 x Temperature /
Humidity Sensor

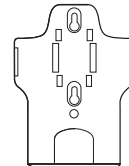

1 x wall mount
bracket



1 x Table stand



2 x AAA UM-4
1.5V battery

RAIN GAUGE

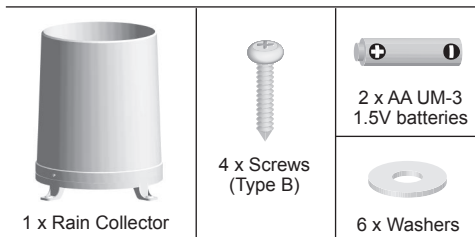

ACCESSORIES - SENSORS

This product can work with up to 3 sensors at any one time to capture outdoor temperature, relative humidity or UV readings in various locations.

Optional wireless remote sensors such as those listed below can be purchased separately. For more information, please contact your local retailer.*

- Solar Panel STC800 connectable to Wind Sensor and Temperature / humidity sensor
- Thermo-hygro THGR800 (3-Ch)
- Thermo-hygro THGR810 (10-Ch)
- UV UVN800
- Pool sensor THWR800

* Features and accessories will not be available in all countries.

OVERVIEW

FRONT VIEW



1. **MODE:** Switch between the different display modes / settings; set clock; set altitude; activate autoscan

2. **MAX/MIN:** Read the max / min memory readings; clear readings
3. **SELECT:** Switch between the different areas
4. **LIGHT:** Activate backlight
5. **▲ / ▼:** Increase / decrease values of the selected setting; toggle between indoor / outdoor channels

BACK VIEW

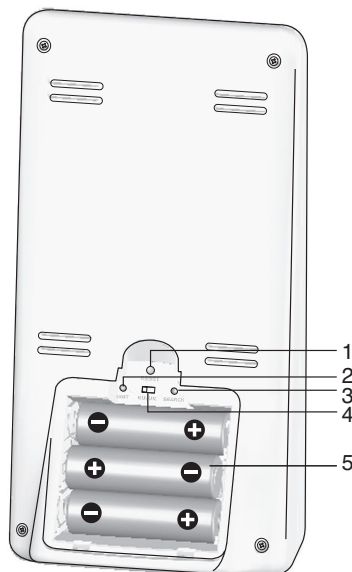

1. **RESET:** Returns unit to default settings
2. **UNIT:** Select unit of measurement
3. **SEARCH:** Searches for sensors or for the radio-controlled clock signal
4. **EU / UK switch:** Select the nearest radio signal (WMR86 only)
5. Battery compartment

LCD DISPLAY

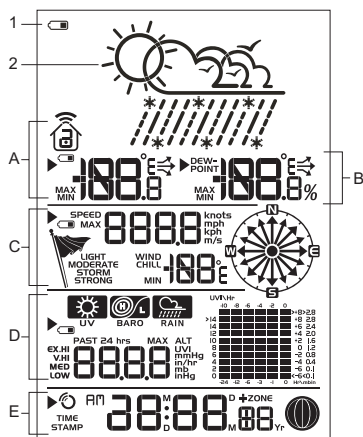



1. : Main unit battery low
 2. Weather forecast
- A. Temperature Area
 - B. Humidity / Dew Point Area
 - C. Wind Speed / Wind Direction / Wind Chill Area
 - D. UVI / Barometer / Rainfall Area
 - E. Clock / Calendar / Moon Phase Area

A Temperature Area



1. Indoor / Outdoor channel temperature and humidity is displayed
2. Outdoor sensor battery is low
3. Selected area icon
4. MAX / MIN temperature is displayed
5. Temperature trend
6. Temperature reading (°C / °F)

B Humidity / Dew Point Area



1. Dew point level – Temperature is displayed
2. MAX / MIN humidity / dew point level is displayed
3. Humidity trend
4. Humidity reading

C Wind Speed / Wind Direction / Wind Chill Area

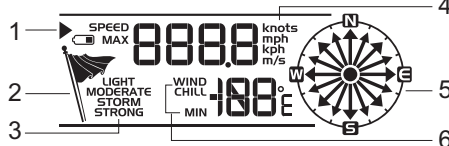

1. Selected area icon
2. Wind speed level indicator
3. Wind speed level description
4. Wind speed reading (m/s, kph, mph or knots)
5. Wind direction display
6. Minimum wind chill is displayed

D UVI / Barometer / Rainfall Area

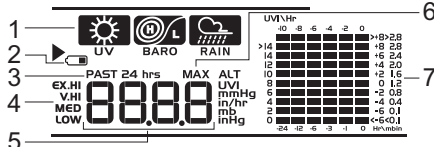

1. UVI / barometer / rainfall reading is displayed
2. Outdoor UV / rain sensor battery is low

3. Past 24hrs rainfall is displayed
4. UVI level indicator
5. UVI / barometric pressure (mmHg, inHg or mb) / rainfall readings (in or mm) for the current hour
6. Maximum UV is displayed
7. UVI / barometric pressure / rainfall historical bar chart display

E Clock / Calendar / Moon Phase Area



1. Clock signal reception indicator
2. Timestamp is displayed
3. Time zone offset
4. Moon phase
5. Time / date / calendar

WIND SENSOR

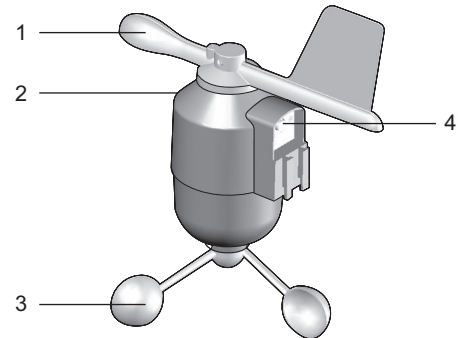

1. Wind direction
2. Wind vane casing
3. Anemometer
4. Solar power socket

RAIN GAUGE

Base and funnel:

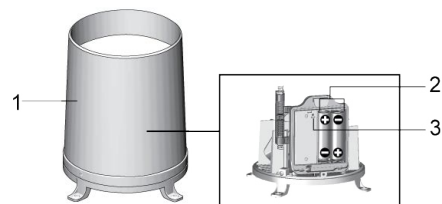

1. Rain gauge
2. Battery compartment
3. RESET button



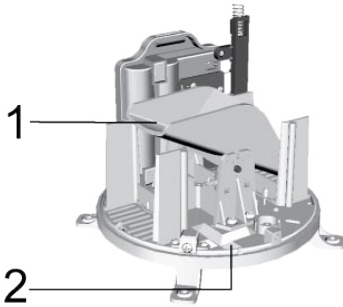

1. Funnel
2. Indicator

OUTDOOR TEMPERATURE / HUMIDITY SENSOR

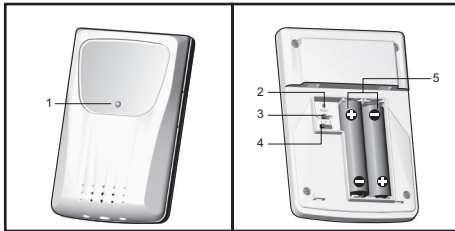

1. LED status indicator
2. **RESET** hole
3. °C / °F: Select temperature unit
4. **CHANNEL** switch
5. Battery compartment

GETTING STARTED

NOTE Install batteries in the remote sensors before the base station matching the polarities (+ and -).

NOTE Use alkaline batteries for longer usage and consumer grade lithium batteries in temperatures below freezing.

SET UP REMOTE WIND SENSOR

The wind sensor takes wind speed and direction readings.

The sensor is battery operated. It is capable of transmitting data to the base station wirelessly within an approximate operating range of 100 meters (328 feet).

To insert batteries:

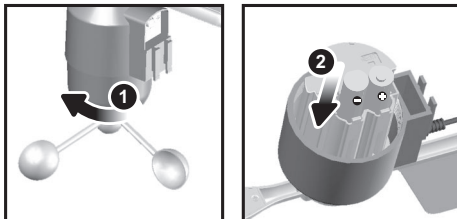

1. Unscrew the anemometer from the wind sensor carefully.
2. Insert batteries matching the polarities (+ / -) and replace the anemometer. Press **RESET** after each battery change.

SET UP REMOTE TEMPERATURE / HUMIDITY SENSOR

The remote sensor can collect data from up to 3 channels.

To set up the remote sensor:

1. Slide open the battery door.
2. Slide channel switch to select a channel (1, 2, 3). Ensure you use a different channel for each sensor.
3. Insert the batteries, matching the polarities (+ / -).
4. Press **RESET** after each battery change.
5. Close the battery door.

SET UP RAIN GAUGE

The rain gauge collects rain and takes rainfall readings. The sensor can remotely transmit data to the base station.

To set up the rain gauge:

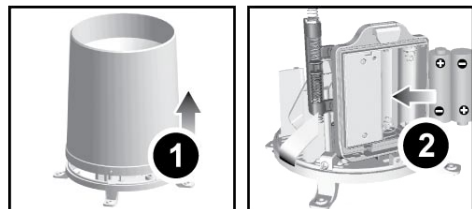

1. Remove screws and slide the cover off in an upwards motion.
2. Insert the batteries (2 x UM-3 / AA), matching the polarities (+ / -). Press **RESET** after each battery change.

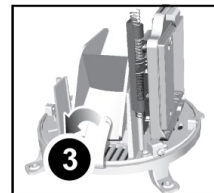

3. Remove the fibre tape.

SET UP BASE STATION

NOTE Install batteries in the remote sensors before the base station matching the polarities (+ and -).

1. Slide open the battery door.

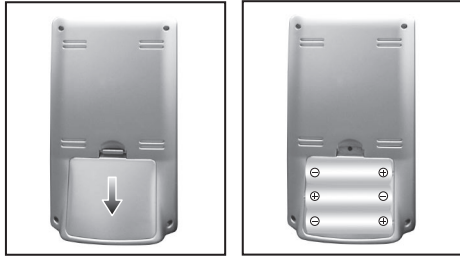

2. Insert the batteries, matching the polarities (+ / -).
3. Press **RESET** after each battery change.
4. Close the battery door.

NOTE Do not use rechargeable batteries. It is recommended that you use alkaline batteries with this product for longer performance.

NOTE Batteries should not be exposed to excessive heat such as sunshine or fire.

The battery icon  may appear in the following areas:

AREA	MEANING
Weather Forecast Area	Battery in the base station is low.
Temperature or Humidity Area	The displayed channel indicates the outdoor sensor for which battery is low.
Wind Speed / Wind Direction / Wind Chill Area	Battery in the wind sensor is low.
UVI / Barometer / Rainfall Area	Battery in the UV / Rain sensor is low.

VERIFY CONNECTION

Before proceeding to install sensors outside, please verify communication to the base station.

WIND SENSOR

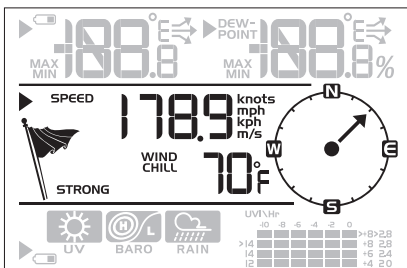



Press **SELECT** until the selected area icon  is in the middle display area.

- Wind speed: Gently rotate the wind vane and confirm a numerical reading on the base station, e.g., | 178.9.

- Wind direction indicator. Move the direction of the wind indication and verify the icon moves in the same direction .

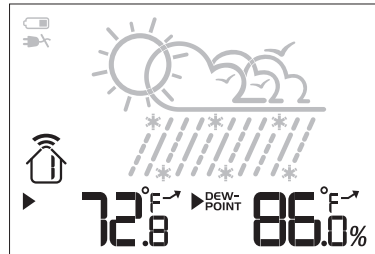

TEMPERATURE / HUMIDITY SENSOR

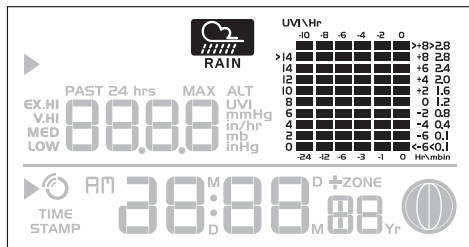

1. Press **SELECT** until the selected area icon  is in the upper display area.
2. Press **▲** / **▼** to select channel 1  and verify a numerical reading.

RAIN GAUGE



1. Press **SELECT** until the selected area icon  is in the lower display area.
2. Press **MODE** until  is displayed.
3. Tilt the tipping funnel on the rain gauge several times and verify a numerical reading on the base station.

TIP If no reading is displayed for a sensor, press the **SEARCH** button on the base station to initiate a wireless sensor search.

MOUNTING / PLACING OF SENSORS

WIND SENSOR

NOTE The sensor should be positioned in an open area away from trees or other obstructions.

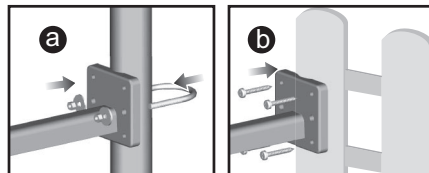

Secure the sensor connector in the desired location:

- a. Align the back of the sensor connector to an existing pole. Secure in place by inserting the ends of the U-bolt into the holes on the sensor connector and securing it with washers and bolts.



OR

- b. Insert 4 type A screws into the holes of the sensor connector. Screw firmly into place, i.e., fence.

Slide wind vane onto the smaller end of the sensor connector.

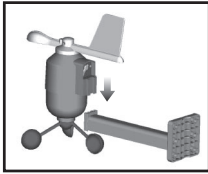

IMPORTANT Ensure that the wind sensor is pointing North to enable it to record accurate readings.

TEMPERATURE / HUMIDITY SENSOR

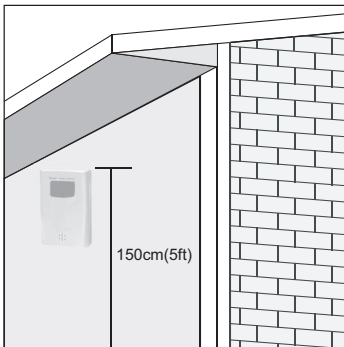

TIP Ideal placements for the sensor would be in any location on the exterior of the home at a height of not more than 1.5 m (5ft) and which can shield it from direct sunlight or wet conditions for an accurate reading.

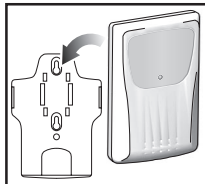

Secure the sensor in the desired location using the wall mount bracket or table stand.

RAIN GAUGE

The base station and rain gauge should be positioned within an effective range: about 100 meters (328 feet) in an open area.

The rain gauge should be mounted horizontally about 1 meter (3 feet) from the ground in an open area away from trees or other obstructions to allow rain to fall naturally for an accurate reading.

To ensure a level plane:

Put a few drops of water on the cross at the base of the funnel to check the horizontal level.

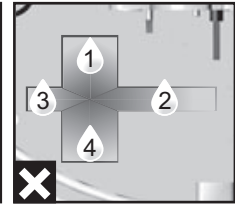
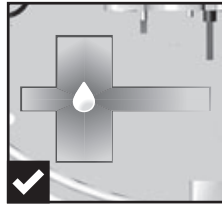

Water will pool to the center of the cross when the rain gauge is level.

If water remains on 1-4, the gauge is not horizontal. If necessary, adjust the level using the screw.

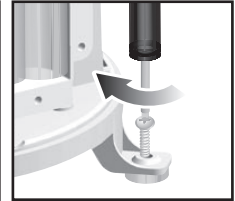
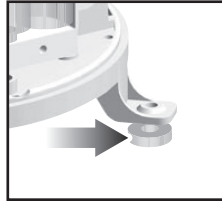

NOTE For best results, ensure the base is horizontal to allow maximum drainage of any collected rain.

TIP Press **RESET** button on base station to erase all testing data.

CLOCK RECEPTION

This product is designed to synchronize its calendar clock automatically once it is brought within range of a radio signal:

WMR86:

- EU: DCF-77 signal: within 1500 km (932 miles) of Frankfurt, Germany.
- UK: MSF-60 signal: within 1500 km (932 miles) of Anthorn, England.



WMR86A:

- WWVB-60 signal: within 3200km (2000 miles) of Fort Collins Colorado.

WMR86 only - slide the **EU / UK** switch to the appropriate setting based on your location. Press **RESET** whenever you change the selected setting.

The reception icon will blink when it is searching for a signal. If the radio signal is weak it can take up to 24 hours to get a valid signal reception.

 indicates the status of the clock reception signal.

ICON	MEANING
	Time is synchronized. Receiving signal is strong
	Time is not synchronized. Receiving signal is weak



To enable (and force a signal search) / disable the clock radio reception (clock synchronization):

1. Press **SELECT** to navigate to the Clock / Calendar / Moon Phase Area. ► will show next to the Area.
2. Press and hold **SEARCH**.

 appears when it is enabled.

NOTE For best reception, the base station should be placed on a flat, non-metallic surface near a window in an upper floor of your home. The antenna should be placed away from electrical appliances and not be moved around when searching for a signal.

CLOCK / CALENDAR

To manually set the clock:

(You only need to set the clock and calendar if you have disabled the clock radio reception).

1. Press **SELECT** to navigate to the Clock Area. ► will show next to the Area.
2. Press and hold **MODE** to change the clock setting. The setting will blink.
3. Press ▲ / ▼ to increase / decrease the setting value.
4. Press **MODE** to confirm.
5. Repeat steps 3 to 4 to set the time zone offset hour (+ / -23 hours), 12 / 24 hour format, hour, minute, year, date / month format, month, date and weekday language.

NOTE If you enter +1 in the time zone setting, this will give you your regional time plus 1 hour.

If you are in the US (WMR86A only) set the clock to:

0 for Pacific time +1 for Mountain time
+2 for Central time +3 for Eastern time.









NOTE The weekday is available in English (E), German (D), French (F), Italian (I), Spanish (S) or Russian (R).

To change the clock display:

1. Press **SELECT** to navigate to the Clock Area. ► will show next to the Area.
2. Press **MODE** to toggle between:
 - Clock with Seconds
 - Clock with Weekday
 - Calendar

MOON PHASE

The Calendar must be set for this feature to work (see **Clock / Calendar** section).

	New Moon		Full Moon
	Waxing Crescent		Waning Gibbous
	First quarter		Third quarter
	Waxing Gibbous		Waning Crescent

AUTO SCANNING FUNCTION

To activate the outdoor temperature and humidity auto-scan function:





1. Press **SELECT** to navigate to the Temperature or Humidity Area. ► will show next to the Area.
2. Press and hold **MODE** to activate auto-scan. The temperature and humidity display will scroll from indoor to ch1 through to ch3.
3. Press any key to stop the auto-scan.

NOTE Channel 1 is used for the outdoor temperature and humidity sensor. Additional temperature and humidity sensors can use other channels.

WEATHER FORECAST

The weather display in the top part of the screen shows the current weather and the weather forecast for the next 12-24 hours within a 30-50 km (19-31 mile) radius.

Weather Forecast Area

ICON	DESCRIPTION
	Sunny
	Partly cloudy
	Cloudy
	Rainy
	Snowy

TEMPERATURE AND HUMIDITY

The weather station displays indoor and outdoor readings for:

1. Temperature / relative humidity (current / maximum / minimum)
2. Trend line
3. Wind chill (current / minimum) and dew point level (current / maximum / minimum)

The weather station can connect up to 3 remote sensors.

NOTE Channel 1 is dedicated for outdoor temperature and humidity.

 shows which remote sensor's data you are viewing.

 appears when indoor data is displayed.

The timestamp records the date and time when storing the temperature and humidity readings in memory.

To select the temperature measurement unit:

Press **UNIT** to select °C / °F.

NOTE The unit of all temperature related displays will be changed simultaneously.

To view temperature (Current / Min / Max temperature) readings:

1. Press **SELECT** to navigate to the Temperature Area. **▶** will show next to the Area.
2. Press **▲ / ▼** to select the channel.
3. Press **MAX / MIN** to toggle between current / MAX / MIN displays.

To view humidity (Humidity, Dew point) readings:

1. Press **SELECT** to navigate to the Humidity Area. **▶** will show next to the Area.
2. Press **▲ / ▼** to select the channel.
3. Press **MODE** repeatedly to toggle between the humidity / dew point displays.
4. Press **MAX / MIN** to toggle between current / MAX / MIN displays.

The timestamp is displayed accordingly in the Clock Area.

To clear the memories and timestamp for the temperature, humidity and dew point readings:

In the Temperature or Humidity Area, press and hold **MAX / MIN** to clear the readings.

NOTE The dew point advises at what temperature condensation will form.

TEMPERATURE AND HUMIDITY TREND

The trend lines are shown next to the temperature and humidity readings. The trend is shown as follows:

RISING	STEADY	FALLING
		

WIND CHILL / DIRECTION / SPEED

The base station provides wind speed and wind direction information.

To read the wind direction find the compass point the is pointing to.

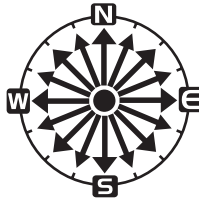

The timestamp records the date and time when storing the wind speed readings.





To select the wind speed unit:

Press **UNIT** to switch between:

- Metres per second (**m / s**)
- Kilometers per hour (**kph**)
- Miles per hour (**mph**)
- Knots (**knots**)

8888
m/s koh mph knots

The wind level is shown by a series of icons:

ICON	LEVEL	DESCRIPTION
	N/A	<2 mph (<4km/h)
	Light	2-8 mph (3~13 km/h)
	Moderate	9-25 mph (~14-41 km/h)
	Strong	26-54 mph (~42-87 km/h)
	Storm	>55 mph (>88 km/h)

To view the maximum wind speed and minimum wind chill readings:

1. Press **SELECT** to navigate to the Wind Speed / Wind Direction / Wind Chill Area. **▶** will show next to the Area.
2. Press **MAX / MIN** to toggle between current / MAX wind speed and current / MIN wind chill displays.

The timestamp is displayed accordingly in the Clock Area.

To clear minimum wind chill reading / maximum wind speed reading:

1. Press **SELECT** to navigate to the Wind Speed / Wind Direction / Wind Chill Area. **▶** will show next to the Area.
2. Press **MAX / MIN** repeatedly until minimum wind chill reading or maximum wind speed reading is displayed.
3. Press and hold **MAX / MIN** to clear the readings.

NOTE The wind chill factor is based on the combined effects of temperature and wind speed. Displayed wind chill is calculated solely from Channel 1 sensors.

UVI / BAROMETER / RAINFALL

The weather station works with one UV sensor and one rain gauge. The station is capable of storing and displaying the hourly history data for the last 10 hours of UV index, and 24 hours of rainfall and barometric pressure readings.

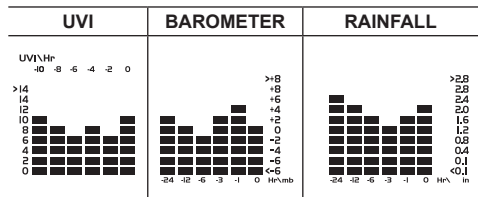

The bar chart display shows the current and historical data for the UV index, barometric pressure and rainfall readings.

NOTE The number shown in the horizontal axis (Hr) indicates how long ago each measurement was taken (e.g. 3 hours ago, 6 hours ago, etc.). The bar represents the measurement taken for that specific 1 hour period.



E.g., if it is 10:30 pm now, the bar plotted directly above -1 shows the reading recorded from 9 to 10 pm and -6 shows the reading recorded earlier in the evening, between 4pm-5pm.

To view the UV / Barometer / Rainfall readings:

1. Press **SELECT** to navigate to the UV / Barometer / Rainfall Area. ► will show next to the Area.
2. Press **MODE** to toggle between UVI / Barometer / Rainfall readings. The corresponding icon will appear:

UVI	BAROMETER	RAINFALL
 UV	 BARO	 RAIN

To select the measurement unit for the barometer or rainfall readings:

In the UV / Barometer / Rainfall Area, press **UNIT** to switch between:

- Barometer: Millimeters of mercury (**mmHg**), inches of mercury (**inHg**), millibars per hectopascal (**mb**).
- Rainfall: Millimeters (**mm**), inches (**in**), recorded for that hour.

NOTE As the purpose of the bar graph is only to provide a quick comparison between the records of the past 24 hours, the vertical axis cannot convert from inches to mm. Therefore, changing the measurement unit will have no effect on the bar graph display.

UV INDEX

The UV index levels are as follows:

UV INDEX	DANGER LEVEL	ICON
0-2	Low	LOW
3-5	Moderate	MED
6-7	High	HI
8-10	Very high	V.HI
11 and above	Extremely high	EX.HI

To view the maximum UV reading:

1. Press **SELECT** to navigate to the UVI / Barometer / Rainfall Area. ► will show next to the Area.
2. Press **MODE** repeatedly to select UV display.
3. Press **MAX / MIN** to toggle between current / MAX UV index display.

The timestamp is displayed accordingly in the Clock Area.

To clear maximum UV reading:

1. Press **SELECT** to navigate to the UVI / Barometer / Rainfall Area. ► will show next to the Area.
2. Press **MODE** repeatedly to select UV display.
3. Press and hold **MAX / MIN** to clear the readings.

BAROMETER

To set the altitude level compensation for the Barometer readings:

1. Press **SELECT** to navigate to the UVI / Barometer / Rainfall Area. ► will show next to the Area.

2. Press **MODE** repeatedly to select Barometric display.
3. Press and hold **MODE** to enter the altitude setting.
4. Press ▲ / ▼ to increase / decrease the setting value.
5. Press **MODE** to confirm the setting.

RAINFALL

To view the recorded rainfall of the current hour or last 24 hours:

1. Press **SELECT** to navigate to the UVI / Barometer / Rainfall Area. ► will show next to the Area.
2. Press **MODE** repeatedly to select Rainfall display.
3. Press **MAX / MIN** repeatedly to toggle between current, past 24 hour rainfall.

BACKLIGHT

Press **LIGHT** to activate the backlight for 5 seconds.

RESET

Press **RESET** to return to the default settings.

SPECIFICATIONS

BASE STATION

Dimensions (L x W x H)	94 x 51 x 182.5 mm (3.7 x 2.0 x 7.2 inches)
Weight	241 g (8.5 oz) without battery
Battery	3 x UM-3 (AA) 1.5V

INDOOR BAROMETER

Barometer unit	mb, inHg and mmHg
Measuring range	700 – 1050mb/hPa
Accuracy	+/- 10 mb/hPa
Altitude setting	Sea level User setting for compensation
Weather display	Sunny, Partly Cloudy, Cloudy, Rainy and Snowy
Memory	Historical data and bar chart for last 24hrs

INDOOR TEMPERATURE

Temp. unit	°C / °F
Displayed range	-50°C to 70°C (-58°F to 158°F)
Operating range	0°C to 50°C (32°F to 122°F)
Accuracy	0°C - 40°C: +/- 1°C (+/- 2.0°F) 40°C - 50°C: +/- 2°C (+/- 4.0°F)
Memory	Current, Min and Max temp. Dew Point w/ Min and Max

INDOOR RELATIVE HUMIDITY

Displayed range	2% to 98%
Operating range	25% to 90%



Accuracy	25% - 40%: +/- 7% 40% - 80%: +/- 5% 80% - 90%: +/- 7%
Memory	Current, Min and Max

RADIO-CONTROLLED / ATOMIC CLOCK

Synchronization	Auto or disabled
Clock display	HH:MM:SS
Hour format	12hr AM/PM or 24hr
Calendar	DD/MM or MM/DD
Weekday in 5 languages	(E, D, F, I, S, R)

REMOTE WIND SENSOR UNIT

Dimensions (L x W x H)	178 x 76 x 214 mm (7 x 3 x 8.4 inches)
Weight	100 g (0.22 lbs) without battery
Wind speed unit	m/s, kph, mph, knots
Speed accuracy	2 m/s ~ 10 m/s (+/- 3 m/s) 10 m/s ~ 56 m/s (+/- 10%)
Direction accuracy	16 positions
Transmission of wind speed signal	Approx. every 56 seconds
Memory	Max wind speed
Battery	2 x UM-3 (AA) 1.5V batteries

OUTDOOR TEMPERATURE / HUMIDITY UNIT

Dimensions (L x W x H)	92 x 60 x 20 mm (3.6 x 2.4 x 0.79 in)
Weight	62 g (2.22oz) without battery
Humidity range	5% to 95%
Humidity accuracy	25% - 40%: +/- 7% 40% - 80%: +/- 5% 80% - 90%: +/- 7%
Temp. unit	°C / °F
Temperature outdoor range	-30°C to 60°C (-22°F to 140°F)
Temperature accuracy	-20°C to 0°C: +/- 2.0°C (+/- 4.0°F) 0°C to 40°C: +/- 1.0°C (+/- 2.0°F) 40°C to 50°C: +/- 2.0°C (+/- 4.0°F) 50°C to 60°C: +/- 3.0°C (+/- 6.0°F)
RF frequency	433MHz
Range	Up to 100 meters (328 feet) with no obstructions
Transmission	Approx. every 102 seconds
Channel no.	3
Batteries	2 x UM-4 (AAA) 1.5V

REMOTE RAIN GAUGE

Dimensions (L x W x H)	114 x 114 x 145 mm (4.5 x 4.5 x 5.7 inches)
Weight	241 g (0.54 lbs) without battery
Rainfall unit	Mm and in
Range	0 mm – 9999 mm
Accuracy	< 15 mm: +/- 1 mm 15 mm to 9999 mm: +/- 7%
Memory	Past 24hrs, hourly from last memory reset
Battery	2 x UM-3 (AA) 1.5V

PRECAUTIONS

- Do not subject the unit to excessive force, shock, dust, temperature or humidity.
- Do not cover the ventilation holes with any items such as newspapers, curtains etc.
- Do not immerse the unit in water. If you spill liquid over it, dry it immediately with a soft, lint-free cloth.
- Do not clean the unit with abrasive or corrosive materials.
- Do not tamper with the unit's internal components. This invalidates the warranty.
- Only use fresh batteries. Do not mix new and old batteries.
- Images shown in this manual may differ from the actual display.
- When disposing of this product, ensure it is collected separately for special treatment and not as household waste.
- Placement of this product on certain types of wood may result in damage to its finish for which Oregon Scientific will not be responsible. Consult the furniture manufacturer's care instructions for information.
- The contents of this manual may not be reproduced without the permission of the manufacturer.
- Do not dispose old batteries as unsorted municipal waste. Collection of such waste separately for special treatment is necessary.
- Please note that some units are equipped with a battery safety strip. Remove the strip from the battery compartment before first use.

NOTE The technical specifications for this product and the contents of the user manual are subject to change without notice.

NOTE Features and accessories will not be available in all countries. For more information, please contact your local retailer.

ABOUT OREGON SCIENTIFIC

Visit our website (www.oregonscientific.com) to learn more about Oregon Scientific products. If you're in the US and would like to contact our Customer Care department directly, please visit: <https://us.oregonscientific.com/service/support.asp>

For international inquiries, please visit: <http://us.oregonscientific.com/about/international.asp>





EU DECLARATION OF CONFORMITY

Hereby, Oregon Scientific, declares that this Pro Weather Station (models: WMR86 / WMR86A) is in compliance with the essential requirements and other relevant provisions of Directive 1999/5/EC. A copy of the signed and dated Declaration of Conformity is available on request via our Oregon Scientific Customer Service.



COUNTRIES RTTE APPROVAL COMPLIED

All EU countries, Switzerland 

and Norway 

FCC STATEMENT

This device complies with Part 15 of the FCC Rules. Operation is subject to the following two conditions: (1) This device may not cause harmful interference, and (2) This device must accept any interference received, including interference that may cause undesired operation.

WARNING Changes or modifications not expressly approved by the party responsible for compliance could void the user's authority to operate the equipment.

NOTE This equipment has been tested and found to comply with the limits for a Class B digital device, pursuant to Part 15 of the FCC Rules. These limits are designed to provide reasonable protection against harmful interference in a residential installation.

This equipment generates, uses and can radiate radio frequency energy and, if not installed and used in accordance with the instructions, may cause harmful interference to radio communications. However, there is no guarantee that interference will not occur in a particular installation. If this equipment does cause harmful interference to radio or television reception, which can be determined by turning the equipment off and on, the user is encouraged to try to correct the interference by one or more of the following measures:

- Reorient or relocate the receiving antenna.
- Increase the separation between the equipment and receiver.
- Connect the equipment into an outlet on a circuit different from that to which the receiver is connected.
- Consult the dealer or an experienced radio / TV technician for help.

DECLARATION OF CONFORMITY

The following information is not to be used as contact for support or sales. Please visit our website at <http://us.oregonscientific.com/service/> for all enquiries.

We

Name: Oregon Scientific, Inc.
Address: 19861 SW 95th Ave., Tualatin,
Oregon 97062 USA
Telephone No.: 1-800-853-8883

declare that the product

Product No.: WMR86 / WMR86A
Product Name: Pro Weather Station
Manufacturer: IDT Technology Limited
Address: Block C, 9/F, Kaiser Estate,
Phase 1, 41 Man Yue St.,
Hung Hom, Kowloon,
Hong Kong

is in conformity with Part 15 of the FCC Rules. Operation is subject to the following two conditions: 1) This device may not cause harmful interference. 2) This device must accept any interference received, including interference that may cause undesired operation.