

DENVER®

Owner's Instructions

Before operating the unit,
please read this manual thoroughly,
and retain it for future reference.

TFD-1906

Art.nr.: 38-2566

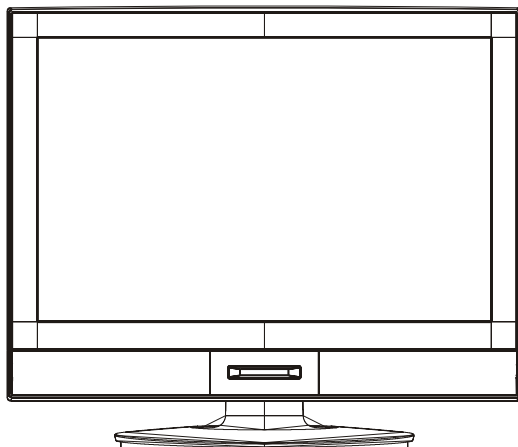

19" TFT LCD TV+DVD COMBO

Operating Instructions

- PAL/NTSC/SECAM B/G,D/K, I
- AC 110-240V 50/60Hz
- SCART IN, PC IN
- TELETEXT
- NTSC PLAYBACK
- INSIDE DVD
- SUPPORT FORMAT: SVCD, VCD, WMA, HDCD,
KODAK PICTURE CD, DVD
MPEG4

Instructions on environment protection



Do not dispose of this product in the usual household garbage at the end of its lifecycle; hand it over at a collection point for the recycling of electrical and electronic appliances. The symbol on the product, the instructions for use or the packing will inform about the methods for disposal.

The materials are recyclable as mentioned in this marking. By recycling, material recycling or other forms of re-utilization of old appliances, you are making an important contribution to protect our environment. Please inquire at the community administration for the authorized disposal location.

TABLE OF CONTENTS

Table of Contents	1	Initial Settings(DVD)	19-20
Specifications	2	Troubleshooting Tips	21
Installation	3	The Causes of interference	22
Important Safety Instruction	4		
Warnings and Cautions	5-7		
Setup	8		
Functional Parts(TV)	9		
Functional Parts(DVD)	10		
Rear view of TV set	11		
Remote Control unit	12-13		
TELETEXT Operations	14		
Remote Control Operation(DVD)	15-16		
MENU Screens	17-18		

SPECIFICATIONS

Receiving System:	B/G, D/K, I
Colour System:	PAL, NTSC, SECAM
LCD Panel:	482.6mm(19 inch) diagonal
Ext. Antenna:	75 Ohm Coaxial Cable
Ext. In/Out:	PC Input, SCART IN
Speaker:	16 Ohm x 2
Audio Output:	3W
Power Consumption:	AC 110-240V 50/60Hz, 60W
Dimension:	W466 x D206 x H415.7 (mm)
Net Weight:	7.0KG

Note: Design and specifications are subject to change without prior notice.

REMOTE CONTROL

Transmitting System: Infrared

Power Supply : DC 3V



Thank you very much for your purchase of this product, the most natural Colour Television Receiver. To enjoy your set to the full from the very beginning, read this manual carefully and keep it handy for ready reference.

INSTALLATION

- Locate the receiver in the room where direct light does not strike the screen. Total darkness or a reflection on the picture screen can cause eyestrain. Soft and indirect lighting is recommended for comfortable viewing.
- Allow enough space between the receiver and the wall to permit ventilation.
- Avoid excessively warm locations to prevent possible damage to the cabinet or premature component failure.
- This TV operates on a DC supply provided by the AC-DC adaptor. The voltage is as indicated on the label on the back cover. Only use the AC-DC adaptor supplied with the TV and never apply an AC mains to the TV directly. The AC-DC adaptor operates on an AC mains supply, the voltage is as indicated on the label of the AC-DC adaptor. Connect the DC plug of the AC-DC adaptor to the DC 12V socket at the back of the TV. Connect the AC-DC adaptor and its mains cord. Insert the mains plug in the wall socket having a mains voltage of 90-240V.
- Do not install the receiver in a location near heat sources such as radiator, air ducts, direct sunlight, or in a place somewhere like close compartment and close area.
- Do not cover the ventilation openings when using the set.

CAUTION

Never tamper with any components inside your set, or any other adjustment controls not mentioned in this manual. The LCD panel used in this product is made of glass. Therefore, it can break when the product is dropped or applied with impact. Be careful not to be injured by broken glass pieces in case the LCD panel breaks. When you clean up dust or stick of a water drop on the LCD panel. The power cord should be pulled out from the plug receptacle, then wipe the receiver with dried soft cloth. During thunder and lightning, unplug the power cord and antenna cord to prevent your TV set from damage. All television receivers are high voltage instruments. All "inside work" on your receiver should be performed only by the TV service personnel.

If some abnormal phenomena happens, may be you have some mis-operation, please take off power and restart your TV set.

IMPORTANT SAFETY INSTRUCTION



WARNING

RISK OF ELECTRIC SHOCK
DO NOT OPEN



WARNING: TO REDUCE THE RISK OF ELECTRIC SHOCK DO NOT REMOVE COVER OR BACK. NO USER-SERVICEABLE PARTS INSIDE. REFER SERVICING TO QUALIFIED SERVICE PERSONNEL.



The lightning flash with arrow head within a triangle is intended to tell the user that parts inside the product are a risk of electric shock to persons.



The exclamation point within a triangle is intended to tell the user that important operating and servicing instructions are in the papers with the appliance.

WARNING: TO REDUCE THE RISK OF ELECTRIC SHOCK DO NOT EXPOSE THIS APPARATUS TO RAIN OR MOISTURE AND OBJECTS FILLED WITH LIQUIDS, SUCH AS VASES, SHOULD NOT BE PLACED ON THIS APPARATUS.

WARNINGS AND CAUTIONS

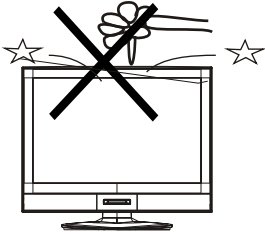

Caution

Do not drop or push objects into the television cabinet slots or openings. Never spill any kind of liquid on the television receiver.

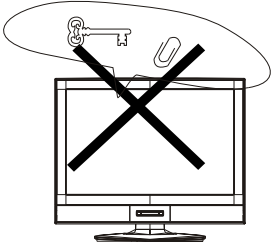

Caution

Do not insert anything in the ventilation holes. If metal or something flammable enters, it may result in fire or electric shock.

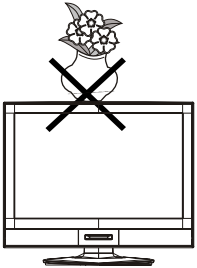

Caution

Do not place objects on this unit, it may damage the screen surface.

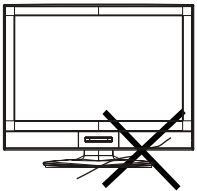

Caution

Do not squash power supply cord under the television receiver.



Caution

Do not throw anything at the set. The screen glass may explode by impact and cause serious injury.

WARNINGS AND CAUTIONS



Caution

Never stand on, lean on, or suddenly push the television or its stand. You should pay special attention to children. Serious injury may result if it should fall.

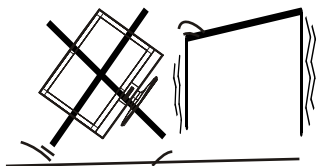

Caution

Do not place your television on an unstable cart, stand, shelf or table. Serious injury to an individual, and damage to the television, may result if it should fall.

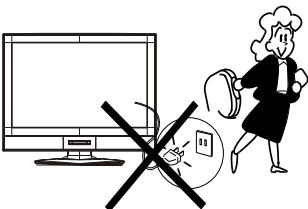

Caution

When the television receiver is not used for an extended period of time, it is advisable to disconnect the AC power cord from the AC outlet.

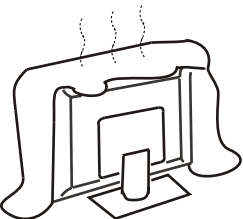

Caution

Do not block the ventilation holes in the back cover. Adequate ventilation is essential to prevent failure of electrical component.

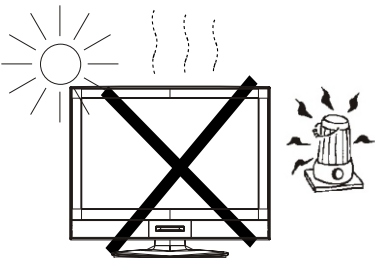

Warning

Avoid exposing the television receiver to direct sunlight and other source of the heat. Do not stand the television receiver directly on other produces which give off heat. E.g. video cassette players. Audio amplifiers. Do not place naked flame sources, such as lighted candle on the television. Do not expose the LCD screen surface to the sun, it may damage the screen surface.

WARNINGS AND CAUTIONS

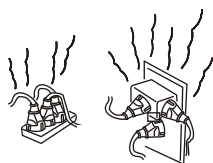

Warning

Take care not to connect many appliances to the same mains socket as this could result in fire or electric shock.

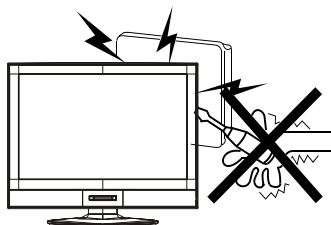

Warning

High voltages are used in the operation of this television receiver. Do not remove the cabinet back from your set. Refer servicing to qualified service personnel.

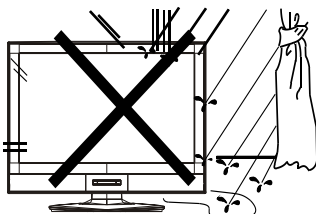

Warning

To prevent fire or electrical shock hazard, Do not expose the television receiver to rain or moisture.

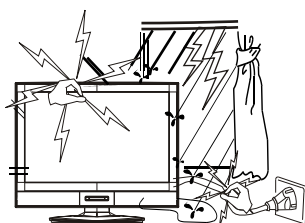

Warning

For your own safety, Do not touch any part of the set, main lead or aerial lead during lightning storms.

Minimum distances

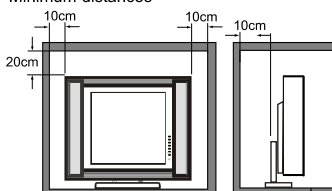

Caution

If the television is to be built into a Compartment or similarly enclosed, the minimum distances must be maintained. Heat build-up can reduce the service life of your television, and can also be dangerous.

SETUP

Insert The Batteries

Remove the battery cover by pressing it and sliding it down.

Insert the 3V battery, make sure the polarity(+/-) of the battery matches the polarity marks inside the unit.
Replace the battery cover by sliding it in unit you hear a click sound.

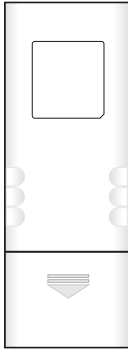

Please insert battery
" +" under metal strip

DIMENSIONS(MM)

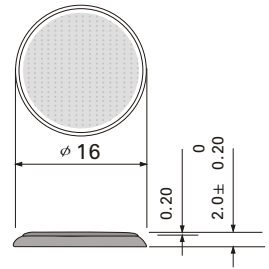

Precautions when using the remote control unit

Do not drop the remote control unit.

Do not subject the remote control unit to physical shocks.

Keep the remote control unit dry. Wetting it may cause the unit to malfunction.

Replace the batteries with new ones when operation of the unit deteriorates.

Corrosion, oxidation, battery-leakage and any other gradually acidic defect of this nature will invalidate the guarantee.

FUNCTIONAL PARTS(TV)

Front View of LCD Set

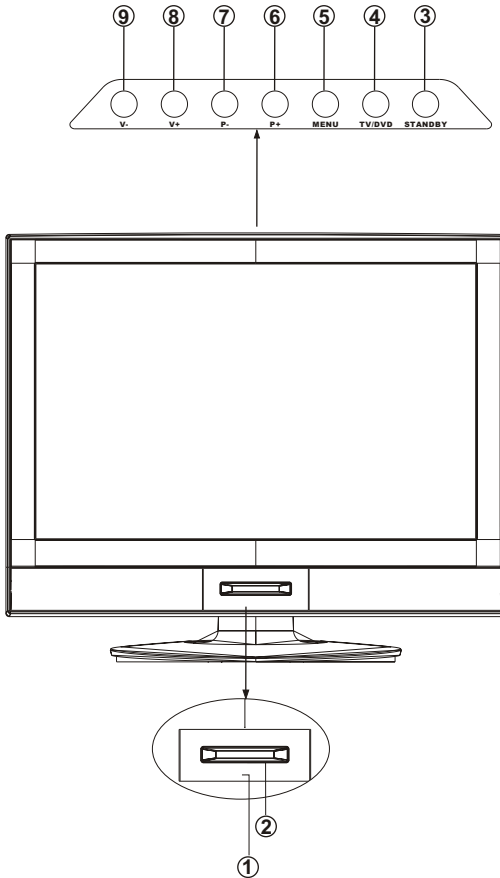

1. LED indicator lamp
2. Remote Sensor
3. Standby Button
4. TV/DVD Button
5. MENU Button
6. P+ Button
7. P- Button
8. V+ Button
9. V- Button

To turn the TV power ON

Put the TV set on the correct place, then connect the DC plug of the AC-DC adaptor to the DC 12V socket at the back of the TV set. Connect the adaptor main cord to the wall outlet, then the LED indicator lamp turns red/green and the TV set is at Standby/work Mode. At Standby Mode, if Standby Button is pressed the power indicator will change to green. It takes a few seconds before the picture appears.

To turn the TV power OFF

Press the Standby Button to make the TV set in Standby Mode, then disconnect the power plug from the wall outlet.

NOTE

If TV is the selected input without signal received and NO operation is performed for about 5 minutes continuously, the TV set will enter standby mode. For any inputs other than TV, the TV set will not enter standby mode automatically without users instruction. If you are not going to use this TV set for a long time, switch off the set and disconnect the power plug from the wall outlet.

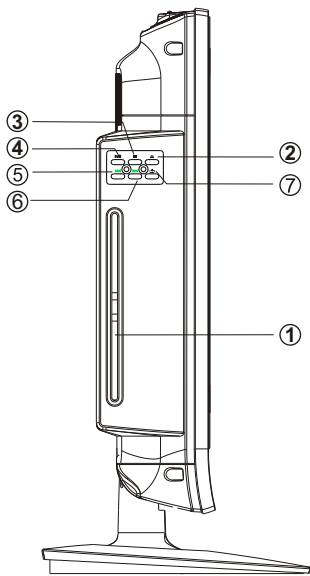

1. DVD Slot
2. Open/Close
3. Stop
4. Play/Pause
5. Preview
6. Next
7. Repeat

Switch this LCD-TV Set to DVD status, insert the disk to DVD slot, and the player will suck it in.

Notes:

1. Do not attach any seal or label to either side (the labeled side or the recorded side) of a disc.

2. Do not use irregularly shaped CDs (e.g., Heart shaped or octagonal) since they may result in malfunctions.

3. Some playback operations of DVDs and Video CDs may be intentionally programmed by software manufacturers. This unit plays DVDS and Video CDs according to disc content designed by the software manufacturer, therefore some playback features may not be available or other functions may be added.

REAR VIEW OF TV SET

- DC IN 12V
- HEADPHONE
- PC IN
- FULL-SCART
- RF INPUT(ANT.)

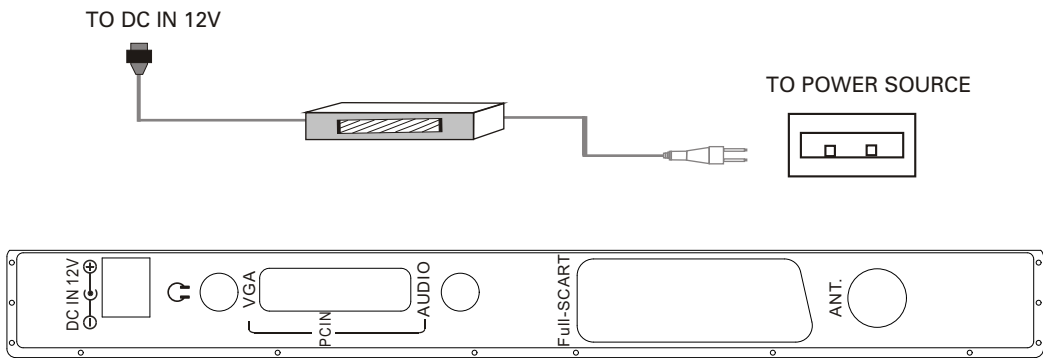

NOTE

Precautions when connecting to other equipment

- When using external equipment with this TV set, please read the instruction manual of the external equipment.
- Switch off all power supplies to the equipment and TV set before connection.
- Always ensure that the input and output terminals are correctly connected.

REMOTE CONTROL UNIT



POWER ON/STANDBY button

Press this button to switch on the TV when at standby mode or enter standby mode.

MUTE button

Press this button to mute or restore sound.

P.M Button

Press this button to select the desired picture mode: NORMAL/SOFT/RICH/CUSTOM.

DISPLAY Button

Press this button to display the setting on the screen.

TIMER Button

Press this button to set the sleep timer, the order shown below(minutes):

0 - 15 - 30 - 45 - 60

When the preset length of time has passed, the TV set enters standby mode.

AV/TV Button

Press AV/TV button, the will be some word show on the right top of the screen, press P+/- to select the AV source, and then press V+/- to enter AV mode.

TV
PC
SCART
DVD

DIGIT Button(0-9)

This TV allows you to select channels from 0 to 255. Press this button to select one-digit,two digit or three -digital channels input options.

To select a one-digit channel(e.g. Channel 8),press this -/-- button to change channel selection to - on screen display and press the 8 button only. To select a two-digit channel(e.g. Channel 28),press this -/-- button to change channel selection to -- on screen display and press 2 and 8 buttons. To select a three-digit channel(e.g. Channel 128), press this -/-- button to change channel selection to --- on screen display and press 1 , 2 and 8 buttons.

REMOTE CONTROL UNIT



MENU Button

Press this button to enter the menu screens for various optional adjustable settings.

P+/P- Button

Press the program up button to select the program forwards. Press the program Down button to select the program Backwards.

V+/V- Button

Press volume up/down buttons to adjust sound level.

RECALL Button

Press this button to return to the previously viewed program.

SWAP Button

You can adjust your TV program list order, press this button, the program swap menu will displayed, as shown below. E.g. to swap channel 0 and 7 ,press

SWAP button, press P+/- to choose FROM and press V+/- to set the channel number as 0 ,and as the same way to set the TO as 7 ,last to do choose the SAVE and press V+/- to implement this fuction.

FROM	CH	0
TO	CH	7
SAVE		⏪ ⏩

S.S Button

Press this button to select the corresponding sound system.

TELETEXT OPERATIONS

For models with Teletext function only.



ON/OFF Button

Press this button to enter or exit the teletext mode.

INDEX Button

Press the button to go to the index page.

REVEAL Button

Press this button to reveal the hidden information for some Teletext pages (e.g. answers to puzzles or riddles). Press again to hide the information.

MIX Button

Press this button enter to mix mode. (For SUBTITLE or NEWSFLASH page, please use mix mode). Press this button again to exit.

SIZE Button

Press this button to change the Teletext screen display mode among the following:

- Upper half screen enlarged
- Lower half screen enlarged
- Normal screen state

HOLD Button

Press this button to hold the Teletext page on display to prevent the page from changing. Press again to release the hold state.

SUB.PAGE

Press this button to display subpage.



DVD Mode:

POWER

Press this button to switch television on or off.

OPEN/CLOSE Button

Press OPEN/CLOSE button to load disc on disc tray. Hold the disc without touching either of its surfaces, position it with the printed title side facing up, align it with the guides, and place it in its proper position. In case of interactive DVDs with playback control, a menu appears on the TV screen.

DVD MENU Button

If play some DVD discs, press this button back to root menu screen.

DISPLAY Button(DISP)

To display player OSD.

GOTO Button

Press this button to go to desired position. The player provides 3 search mode. When the above items are showed on TV screen, you can input number to locate desired sector, then press PLAY to commence play. The number you input is invalid if it is beyond the track's capacity.

SUBTITLE Button

To press this button, you can change the subtitle language from one selected to the initial settings to a different language, if available.

AUDIO Button

To press this button, you can change the audio language from the one selected at settings to a different language, if available.

PROGRAM Button

Place a track on the program list. Press PROGRAM button, then the PROGRAM will appear on TV screen now you can press > and ENTER button to select START option and enjoy the desired tracks.



PLAY/PAUSE Button(▶|◀)

Press this button to start playback. Press this button again to pause playback.

STOP Button(■)

When this button is pressed once, the unit records the stopped point, from where playback will resume (resume function) if PLAY is pressed afterwards. But if STOP button is pressed again instead of PLAY button, there will be no resume function.

DVD SETUP Button

You can enjoy picture frame forward by pressing this button.

REPEAT Button(REP)

To press this button you can repeatedly play a title (DVD) or all tracks (CD) when ALL appears on TV screen, you can repeatedly play a chapter (DVD) or a single track (CD) when Repeat chapter appears on TV screen, you can cancel repeat functions when no Repeat off appears on TV screen.

FR/FF Button(▶▶, ◀◀)

These buttons allow skipping ahead/back at 5-level speed. Press PLAY button to return to normal playback.

PREV/NEXT Button(▶▶, ◀◀)

Press these buttons to go to the previous/next chapter (DVD).

MENU SCREENS

This TV allows you to adjust any setting from the menu screens using **MENU** , **V+/-** and **P+/-** buttons.

Press **MENU** button to display the menu, press **P+/-** to change menu from one to another, **V+/-** to enter the chosen menu, press **P+/-** to select the item, and then press **V+/-** to adjust each item.

Press **MENU** again to exit the menu mode.

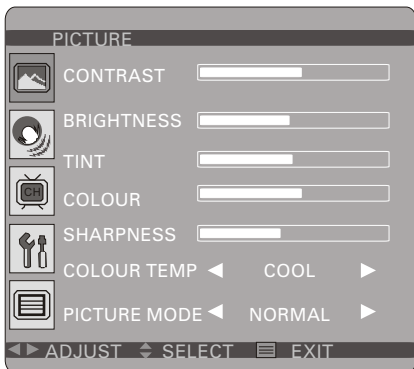

PICTURE MENU

You can adjust the contrast, brightness, tint(NTSC only) colour, sharpness.

COLOUR TEMP: NORMAL / WARM / COOL

PICTURE MODE: NORMAL / SOFT / RICH / CUSTOM

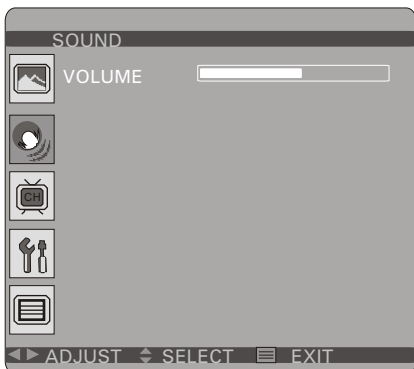

SOUND MENU

Enter sound menu, you can adjust VOLUME.

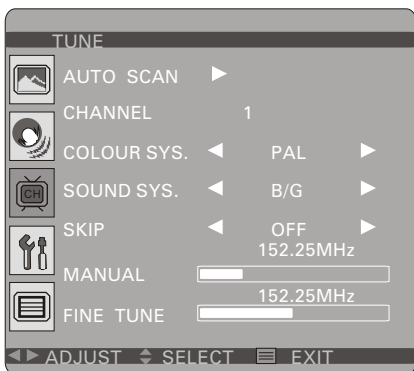

TUNE MENU

AUTO SCAN: Press **V+/-** to begin auto search program, and press menu to exit auto search.

CHANNEL: The number is the current channel, and you can also change channel from one to another.

COLOUR SYS. PAL/NTSC/SECAM (optional)

SOUND SYS. B/G,D/K,I,M,L,L (optional)

SKIP: Set this item on to skip the channel which you are watching.

MANUAL: To start searching until a program is searched, or press **MUNE** to exit.

Fine Tune: Frequency data can be fine-tuned in upward or downward by the **VOL +/-** buttons.

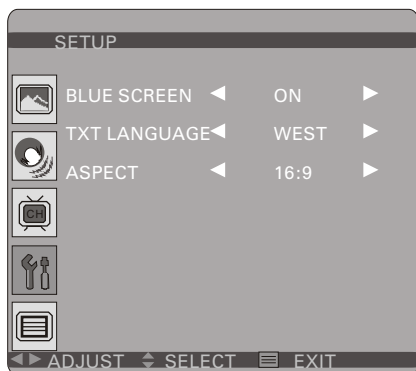

SETUP MENU

BLUE SCREEN: You can set background ON or OFF.

TXT LANGUAGE:

ASPECT: You can set the picture display mode 16:9, 4:3, ZOOM1, and ZOOM2, PANORAMA.



OSD MENU

You can choose the language, adjust the H-position, V-position, duration and halftone.



PC MENU (under PC mode only)

You can adjust the CONTRAST, BRIGHTNESS

HPOS/VPOS Press the VOL +/- buttons to adjust the picture Horizontal and Vertical position.

CLOCK Press the VOL +/- to minimize any vertical bars or stripes visible on the screen background.

PHASE When necessary, adjust the pixel phase of the picture to avoid picture interference.

AUTO CONFIG To adjust the screen position automatically. It will take a few seconds and during this process the screen will be black.

NOTE:

If the set is cold, there may be a small flicker when the set is switched on. It is normal. There is nothing wrong with the set.

If possible, use the VESA 1024X768@60HZ video mode to obtain the best image quality for your LCD monitor. Under other resolutions some scaled or processed pictures may appear on the screen.

Some dot defects may appear on the screen, like red, green or blue Spots. However, this will have no impact or effect on the monitor performance.

Do not press the LCD screen with your finger for a long time as it may incur some damage to the screen.

INITIAL SETTINGS(DVD)

COMMON PROCEDURES OF INITIAL SETTINGS

Press SETUP button to get the setup menu. Use direction buttons "◀▶" to select the preferred item. After finishing settings, press SETUP again to TV display.

The following menu items can be changed:

GENERAL: selects the GENERAL PAGE menu.

AUDIO : selects the Audio menu.

DOLBY : selects the DOLBY DIGITAL SETUP menu.

PREFERENCE: selects the PREFERENCE PAGE menu.

GENERAL SETUP PAGE

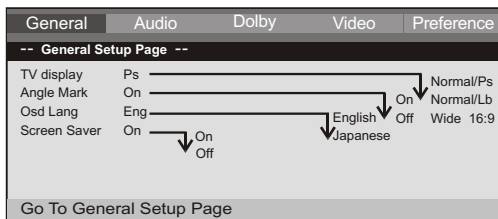

The following menu items can be changed:

TV DISPLAY: selects the aspect ratio of the playback picture.

NORMAL/PS: pan & scan display.

NORMAL/LB: letterbox display.

WIDE: widescreen display.

ANGLE MARK: viewing angles change option

(if available). See changing the angles on page 10.

SCREEN SAVER: this is to turn on/off screen saver.

AUDIO SETUP PAGE

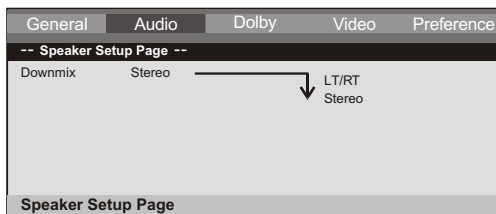

This page is for setup speaker output.

DOWNMIX Stereo

LT/RT: 2ch output, main channel with surround.

STEREO: 2ch output, main right channel with right surround; main left channel with left surround.

DOLBY DIGITALSETUP PAGE

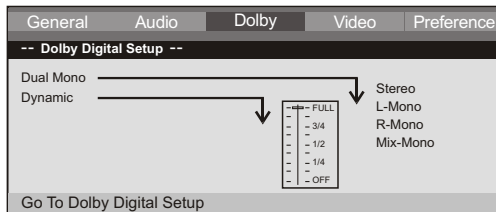

The following menu items can be changed:

DUAL MONO: Reproduction mode, used only when the input consists of two independent audio channels(1/1 mode). Possible selections are: STEREO: Reproduce both channels as is.

L-MONO: Reproduce the left channel only.

R-MONO: Reproduce the right channel only.

The default is STEREO.

DYNAMIC: Dynamic range compression.

VIDEO DIGITALSETUP PAGE

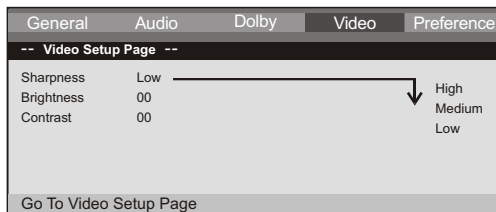

The following menu items can be changed:

Sharpness: sharpness value.

Brightness: brightness value.

Contrast: contrast value.

PREFERENCE SETUP PAGE

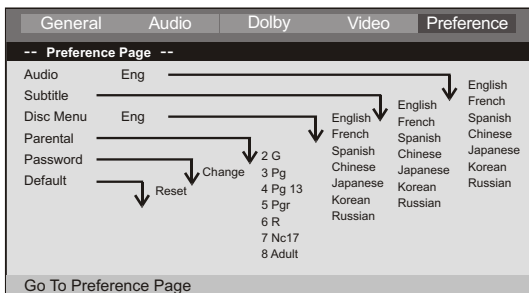

The following menu items can be changed:

AUDIO: Selects a language for audio(if available).

SUBTITLE: Selects a language for subtitles(if available).

DISC MENU: Selects a language for DISC menus (if available).

PARENTAL[DVD only]: This is to disable the playing of specified DVDs which are unsuitable for children. Some DVDs are encoded with specific rating level. If the rating level of the disc is higher than that preset in the setup operation, playback of the disc will be prohibited. After selecting one of the PARENTAL items the screen will change to the PASSWORD page, and password is required , The factory initial setting is 1369.

PASSWORD: Selects the menu setup PASSWORD CHANGE PAGE.

PASSWORD CHANGE PAGE

PASSWORD CHANGE PAGE		
OLD PASSWORD		[XXXX]
NEW PASSWORD		[YYYY]
CONFIRM PASSWORD		[YYYY]
<input type="button" value="OK"/>		

OLD PASSWORD: Enter the OLD password, (Factory setting is 1369), and the cursor will jump automatically to NEW PASSWORD.

NEW PASSWORD: Enter the NEW password. Enter 4 digits from the remote control unit numeric buttons, and the cursor will automatically jump to CONFIRM PASSWORD.

CONFIRM PASSWORD: Confirm the NEW password by entering it again. If the confirmation is incorrect, the cursor will stay in this column. After entering, the correct new password again, the cursor will jump automatically to OK.

OK: When cursor is on this button, press ENTER key to confirm setting.

DEFAULT: Back to the factory setting.

Before calling for service, you can check the following items on symptoms and solutions.

No picture:

- Check other channel, maybe station problem.
- Adjust the tuning control.
- Ensure that the input setting is at TV state.
- Ensure that the LCD is on.
- Ensure that the equipment is connected properly.

No sound and distorted sound:

- Ensure that the input settings for the TV and sound are proper.
- Adjust the tuning control.
- Probably local interference, such as an appliance.
- Re-orient aerial (if indoor type).
- Ensure that the equipment is connected properly.

No remote Control:

- Check the battery are installed with the correct polarity.
- Point the remote control unit at the remote control sensor and operate.
- Remove the obstacles between the remote control and the remote control sensor.
- Operate the remote control unit at a distance of not more than 8 meters from the remote control sensor.

Troubleshooting tips(PC mode):

NO SYNC SIGNAL or POWER SAVE displayed

- Check if the wire is connected correctly.
- Ensure the computer or other equipments are at power on mode.
- Ensure the computer is not at power save mode.
- Ensure the TV input setting is at pc mode.

Invalid Scan Fred displayed

- Check if the input setting is compatible to the monitor specification.
- Check if the wire is connected correctly.

Led lamp indicator on but no picture

- Check the monitor setting : contrast ,brightness.
- Check if the wire is connected correctly.

Some unusual spots on screen:

- Some dot defects may appear on the screen, like red, green or blue, Spots, However, this will have no impact or effect on the monitor performance.

THE CAUSES OF INTERFERENCE

Incorporated in your TV receiver are the most up-to-date devices to eliminate interference. Local radiation however, can create disturbances which visibly affect your picture. Proper installation, a good aerial are your best safe-guards against these disturbances.

RF INTERFERENCE

Moving ripples across the screen are caused by nearby transmitting or receiving short-wave radio equipment.

DIATHERMY

Herringbone pattern and partial picture loss can result from the operation of diathermy equipment from a nearby doctor's surgery or hospital.

SNOW

Weak TV signals from long distant stations result in an instead picture and give the effect of falling snow. An antenna adjustment or antenna amplifier may be needed.

GHOST

Multiple image caused by TV signals reflected back from surrounding buildings, hills, aircraft, ect. Is minimized by correct aerial positioning.

CAR IGNITION

Nearby cars and electrical motors can cause small streaks across the picture or make the picture roll.

DENVER®

www.denver-electronics.com