



Micro Hi-Fi System

MCM277

Register your product and get support at
www.philips.com/welcome

User manual
Manuel d'utilisation
Manual de usuario
Benutzerhandbuch
Gebruikershandleiding
Manuale dell'utente
Användarhandbok
Brugervejledning



PHILIPS



Important notes for users in the U.K.

Mains plug

This apparatus is fitted with an approved 13 Amp plug. To change a fuse in this type of plug proceed as follows:

- 1 Remove fuse cover and fuse.
- 2 Fix new fuse which should be a BS1362 3 Amp, A.S.T.A. or BSI approved type.
- 3 Refit the fuse cover.

If the fitted plug is not suitable for your socket outlets, it should be cut off and an appropriate plug fitted in its place.

If the mains plug contains a fuse, this should have a value of 3 Amp. If a plug without a fuse is used, the fuse at the distribution board should not be greater than 3 Amp.

Note: The severed plug must be disposed of to avoid a possible shock hazard should it be inserted into a 13 Amp socket elsewhere.

How to connect a plug

The wires in the mains lead are coloured with the following code: blue = neutral (N), brown = live (L).

- As these colours may not correspond with the colour markings identifying the terminals in your plug, proceed as follows:
 - Connect the blue wire to the terminal marked N or coloured black.
 - Connect the brown wire to the terminal marked L or coloured red.
 - Do not connect either wire to the earth terminal in the plug, marked E (or $\frac{1}{2}$) or coloured green (or green and yellow).

Before replacing the plug cover, make certain that the cord grip is clamped over the sheath of the lead - not simply over the two wires.

Copyright in the U.K.

Recording and playback of material may require consent. See Copyright Act 1956 and The Performer's Protection Acts 1958 to 1972.

Italia

DICHIARAZIONE DI CONFORMITA'

Si dichiara che l'apparecchio MCM277 Philips risponde alle prescrizioni dell'art. 2 comma 1 del D.M. 28 Agosto 1995 n. 548.

Fatto a Eindhoven

Philips Consumer Electronics
Philips, Glaslaan 2
5616 JB Eindhoven, The Netherlands

Norge

Typeskilt finnes på apparatens underside.

Observer: Nettbryteren er sekundert innkoplet. Den innebygde nettdelen er derfor ikke frakoplet nettet så lenge apparatet er tilsluttet nettkontakten.

For å redusere faren for brann eller elektrisk støt, skal apparatet ikke utsettes for regn eller fuktighet.

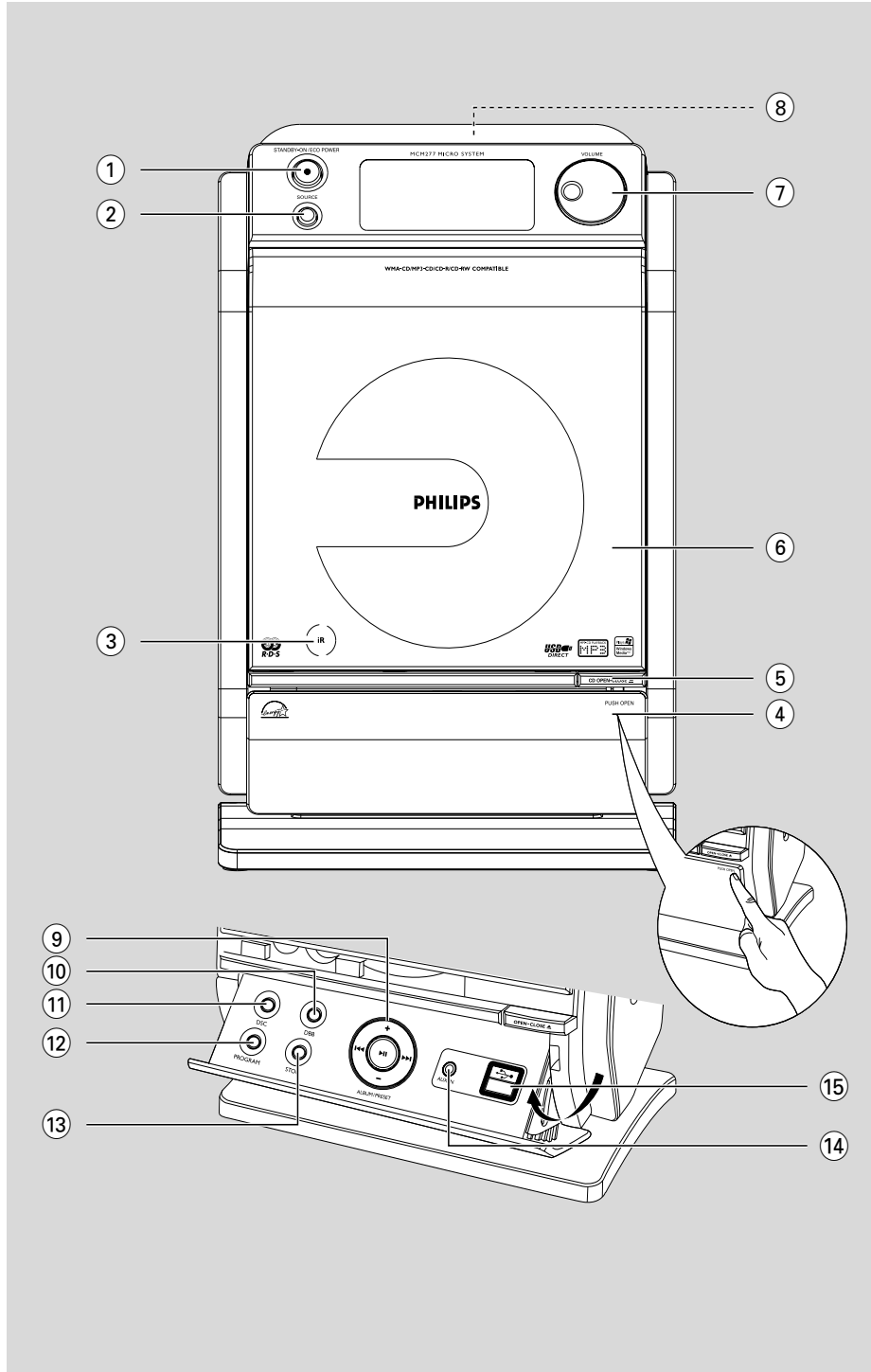

DK

Advarsel: Usynlig laserstråling ved åbning
når sikkerhedsafbrydere er ude af funktion.
Undgå udsættelse for stråling.

Bemærk: Netafbryderen er sekundært
indkoblet og afbryder ikke strømmen fra
nettet. Den indbyggede netdel er derfor
tilsluttet til lysnettet så længe netstikket
sidder i stikkontakten.

S

Klass 1 laserapparat
Varning! Om apparaten används på annat
sätt än i denna bruksanvisning specificerats,
kan användaren utsättas för osynlig
laserstrålning, som överskrider gränsen för
laserklass 1.

Observera! Stömbrytaren är sekundärt
kopplad och bryter inte strömmen från
nätet. Den inbyggda nätdelen är därför
ansluten till elnätet så länge stickproppen
sitter i vägguttaget.

SF

Luokan 1 laserlaite

Varoitus! Laitteen käyttäminen
muulla kuin tässä käyttöohjeessa mainitulla
tavalla saattaa altistaa käyttäjän
turvallisuusluokan 1 ylittävälle
näkyttömälle lasersäteilylle.

Oikeus muutoksiin varataan. Laite ei
saa olla alttiina tippu- ja roiskevedelle.

Huom. Toiminnanvalitsin on kytketty
toisipuolelle, eikä se kytke laitetta irti
sähköverkosta. Sisäänrakennettu verkko-
osa on kytkettynä sähköverkkoon aina
silloin, kun pistoke on pistorasiassa.



Index

English 6

Français 30

Español 55

Deutsch 79

Nederlands 104

Italiano 128

Svenska 152

Dansk 175

English

Français

Español

Deutsch

Nederlands

Italiano

Svenska

Dansk

Contents

General Information

Supplied accessories	7
Environmental Information	7
Safety Information	7

Controls

Controls on the set (illustrations on page 3)	8
Remote control	9

Installation

Placing MCM277	10
Mounting stand onto the set	10
Mounting MCM277 onto walls	10
Rear connections	11
Connecting an additional appliance	12
Connecting a USB device or memory card	12
Connecting a non-USB device	13
Using AC power	13

Preparation

Using the remote control	14
To replace the remote controls' battery	
Setting the clock	14

Basic Functions

Switching on/off the set and selecting functions	15
Switching between Standby and ECO POWER mode	15
Auto-standby	15
Volume control	15
Volume adjustment	15
MUTE	15
Sound control	16
DSC	16
Digital Sound Control enables you to select predefined sound settings	16
DBB	16
Displaying the clock	16

CD

Discs for playback	17
About MP3/WMA	17
Playing discs	17
Selecting and searching	18
Selecting a different track	18
Finding a passage within a track during playback	18
Programming tracks	19
Erasing the program	19
Different play modes: REPEAT, SHUFFLE	20

Display track information (MP3/WMA only)	20
--	----

Tuner

Tuning to radio stations	21
Programming radio stations	21
Autostore: Automatic programming	21
Manual programming	21
To listen to a preset station	21
RDS	22
Switching through RDS information	22
Tuning to a program type (PTY)	22
Automatic clock setting via RDS	22
RDS News and Traffic	
Announcement (TA)	22
Activating the NEWS function	22
Deactivating NEWS	22

USB

Using a USB mass storage device	
By connecting a USB mass storage device to the Hi-Fi system, you can enjoy the device's stored music through the powerful speakers of Hi-Fi system.	23
Playing a USB mass storage device	23
Compatible USB mass storage devices	23

AUX

AUX (Listening to an external source)	24
---	----

Timer

Setting the timer	25
Activating and deactivating TIMER	25
SLEEP	25

Specifications	26
----------------------	----

Maintenance	26
-------------------	----

Troubleshooting	27
-----------------------	----

Appendix

How to mount your MCM277 onto walls ...	16
What's in the supplied mounting kits	18
What else you'll need	18
Preparation	18
Mounting your MCM277	18

General Information

English

Congratulations on your purchase and welcome to Philips!

To fully benefit from the support that Philips offers, register your product at www.philips.com/welcome.

Supplied accessories

- 2 speaker boxes including 2 speaker cables
- remote control (with 1 × CR2025 battery)
- MW loop antenna
- FM wire antenna
- stand
- mounting kit

Environmental Information

All unnecessary packaging has been omitted. We have tried to make the packaging easy to separate into three materials: cardboard (box), polystyrene foam (buffer) and polyethylene (bags, protective foam sheet).

Your system consists of materials which can be recycled and reused if disassembled by a specialized company. Please observe the local regulations regarding the disposal of packaging materials, exhausted batteries and old equipment.

Disposal of your old product

Your product is designed and manufactured with high quality materials and components, which can be recycled and reused.

When this crossed-out wheeled bin symbol is attached to a product it means the product is covered by the European Directive 2002/96/EC

Please inform yourself about the local separate collection system for electrical and electronic products.



Please act according to your local rules and do not dispose of your old products with your normal household waste. The correct disposal of your old product will help prevent potential negative consequences for the environment and human health.

Safety Information

- Place the system on a flat, hard and stable surface.
- Place the system in a location with adequate ventilation to prevent internal heat build-up in your system. Allow at least 10 cm (4 inches) clearance from the rear and the top of the unit and 5 cm (2 inches) from each side.
- The ventilation should not be impeded by covering the ventilation openings with items, such as newspapers, table-cloths, curtains, etc.
- Do not expose the system, batteries or discs to excessive moisture, rain, sand or heat sources caused by heating equipment or direct sunlight.
- No naked flame sources, such as lighted candles, should be placed on the apparatus.
- No objects filled with liquids, such as vases, shall be placed on the apparatus.
- If the system is brought directly from a cold to a warm location, or is placed in a very damp room, moisture may condense on the lens of the disc unit inside the system. Should this occur; the CD player would not operate normally. Leave the power on for about one hour with no disc in the system until normal playback is possible.
- The mechanical parts of the set contain self-lubricating bearings and must not be oiled or lubricated.
- **When the system is switched to Standby mode, it is still consuming some power. To disconnect the system from the power supply completely, remove the AC power plug from the wall socket.**

Controls

Controls on the set (illustrations on page 3)

- ① **STANDBY-ON/ ECO POWER**
 - press briefly to switch the set on or off (standby/ ECO POWER);
 - **In standby or Eco Power mode:** press and hold to toggle between Standby and ECO POWER mode (power-saving mode)
 - **Red indicator:** lights up red when the set is switched to ECO POWER mode
- ② **SOURCE**
 - selects sound source **CD, USB, TUNER** or **AUX**
 - **In standby or Eco Power mode:** switches the set on and selects sound source **CD, USB, TUNER** or **AUX**
- ③ **IR**
 - sensor for the infrared remote control
 - **Helpful hints:** Always point the remote control towards this sensor.
- ④ **PUSH OPEN**
 - push to unfold or fold the control panel
- ⑤ **CD OPEN • CLOSE ▲**
 - opens/closes the CD door
- ⑥ **CD door**
- ⑦ **VOLUME**
 - adjusts the volume level
 - **Clock/Timer:** adjusts the hours and minutes
- ⑧ 
 - 3.5 mm headphone socket
 - **Helpful hints:**
 - Adjust the volume to a moderate level before you plug in the headphones.
 - Connecting headphones will switch off the speakers.
- ⑨ **ALBUM/ PRESET + /-**
 - **CD/USB:** selects albums (for MP3/WMA only)
 - **TUNER:** selects a preset radio station

◀◀ / ▶▶

 - **CD/USB:** skips or searches CD tracks/titles backwards/forwards
 - **Tuner:** tunes to radio stations

▶ II

 - **CD/USB:** starts or pauses playback
- ⑩ **DBB (Dynamic Bass Boost)**
 - turns the bass enhancement on/off
- ⑪ **DSC (Digital Sound Control)**
 - selects predefined sound settings: **ROCK, JAZZ, POP, CLASSIC**
- ⑫ **PROGRAM**
 - **CD/USB:** programs tracks
 - **Tuner:** programs preset radio stations
- ⑬ **STOP**
 - **CD/USB:** stops playback; erase a program
- ⑭ **AUX-IN**
 - connects to the AUDIO OUT jack on the external appliance
- ⑮ 
 - jack for the external USB mass storage device

Controls

English

Remote control

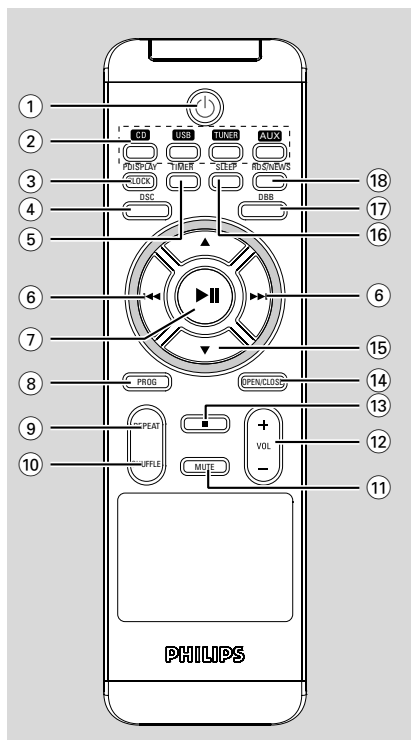

Notes for remote control:

– First select the source you wish to control by pressing one of the source select keys on the remote control (for example **CD, TUNER**).

– Then select the desired function (for example **▶ II**, **◀◀**, **▶▶**).

① **Power**

- press briefly to switch the set on or off (standby/ECO POWER);
- **In standby or Eco Power mode:** press and hold to toggle between Standby and ECO POWER mode (power-saving mode)

② **Source buttons**

USB

- selects **USB** source
- **In standby or Eco Power mode::** switches the set on and selects **USB** source.

CD

- selects **CD** source
- **In standby or Eco Power mode::** switches the set on and selects **CD** source.

TUNER

- selects **TUNER** source and toggles between the wavebands: FM and MW
- **In standby or Eco Power mode::** switches the set on and selects **TUNER** source

AUX

- selects the audio input from an additional connected appliance
- **In standby or Eco Power mode::** switches the set on and selects the audio input from an additional connected appliance

③ **CLOCK**

- **Clock:** - displays the set time
- **In standby mode:** enters the clock setting mode (press and hold for more than 2 seconds)

④ **DSC (Digital Sound Control)**

- selects predefined sound settings: **ROCK, JAZZ, POP, CLASSIC**

⑤ **TIMER**

- displays the timer setting
- switches the timer on/off
- enters the timer setting mode (press and hold for more than 2 seconds)

⑥ **◀◀ / ▶▶**

- **CD/USB:** skips or searches CD tracks backwards/forwards
- **Tuner:** tunes to radio stations

⑦ **▶ II**

- **CD/USB:** starts or pauses playback

⑧ **PROG**

- **CD/USB:** programs tracks
- **Tuner:** programs preset radio stations

⑨ **REPEAT**

- selects continuous playback

⑩ **SHUFFLE**

- selects random playback

⑪ **MUTE**

- switches the sound off temporarily

Controls

- ⑫ **VOL +/-**
 - adjusts the volume level
 - **Clock/Timer:** adjusts the hours and minutes
- ⑬ **■**
 - **CD/USB:** stops playback; erase a program
- ⑭ **OPEN/CLOSE**
 - opens/closes the CD door
- ⑮ **▲ / ▼**
 - **CD/USB:** selects the next/previous album (for MP3/WMA only)
 - **TUNER:** selects a preset radio station
- ⑯ **SLEEP**
 - set the sleep timer
- ⑰ **DBB (Dynamic Bass Boost)**
 - turns the bass enhancement on/off
- ⑱ **RDS/NEWS**
 - **Tuner:** selects RDS (Radio Data System) information
 - **CD/USB/AUX:** activates/deactivates news

Installation

Placing MCM277

With the detachable stand and by-packed wall mounting kit, MCM277 allows you to place it in two ways: **on desktops with stand** or **on walls without stand**.

Mounting stand onto the set

MCM277 is equipped with a stand. To mount the stand onto the set,

- ① Put MCM277 on a flat and firm surface, rear side facing up
- ② As shown, align the stand to the slots at set's bottom, ▼ **FRONT** facing down

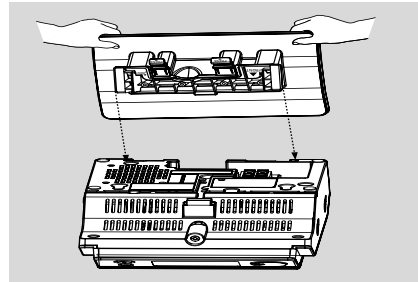

- ③ Push the stand down into the slots
→ When the stand is in place, you will hear a click

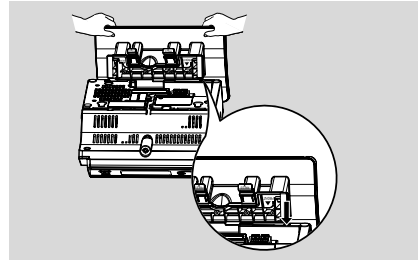

Mounting MCM277 onto walls

See **Appendix: How to mount your MCM277 onto walls** to learn more about wall mounting.

Installation

English

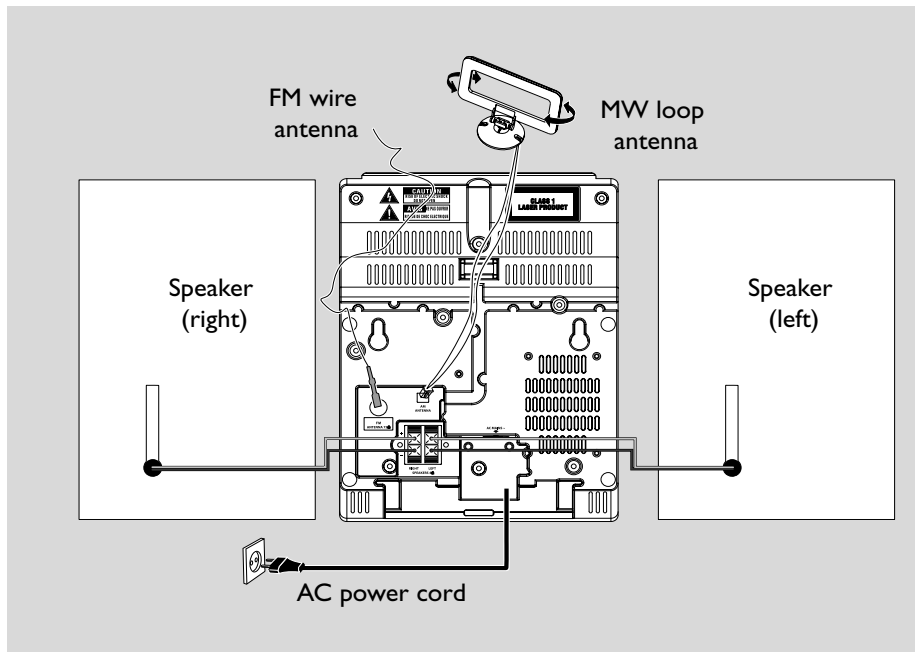

Rear connections

Warning:

- Never make or change connections with the mains supply switched on.
- Install your set near the AC outlet and where the AC power plug can be reached easily.

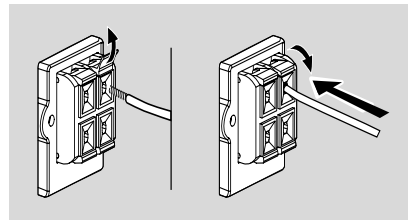

A Speaker connections

Use the supplied speakers only. Using other speakers can damage the set or the sound quality will be negatively affected.

- Connect the cable of the left speaker to **LEFT** (red and black) and the cable of the right speaker to **RIGHT** (red and black) as follows:
 - a. Press the clip of the red terminal and fully insert the stripped portion of the colored (or marked) speaker cable into the socket, then release the clip
 - b. Press the clip of the black terminal and fully insert the stripped portion of the black (or unmarked) speaker cable into the socket, then release the clip

B Antenna connections MW antenna

- 1 Assemble the loop antenna as shown:

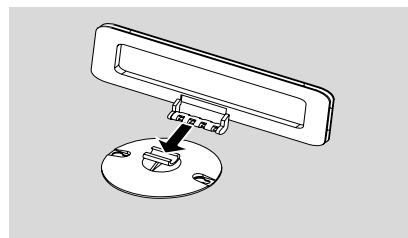

Installation

Or

Insert the loop antenna into the slot on the set

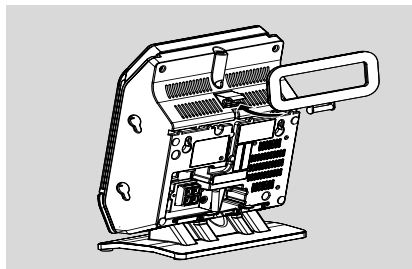

- 2 Fit the plug of the loop antenna to AM (MW) ANTENNA as shown below
- 3 Adjust the position of the antenna for optimal reception (as far away as possible from the TV, VCR or other radiation sources)

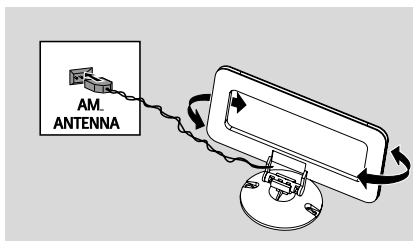

FM antenna

The wire antenna supplied can only be used to receive nearby stations. For better reception we recommend using a cable antenna system or an outdoor antenna.

- 1 Extend the wire antenna and fit it to FM ANTENNA as shown below

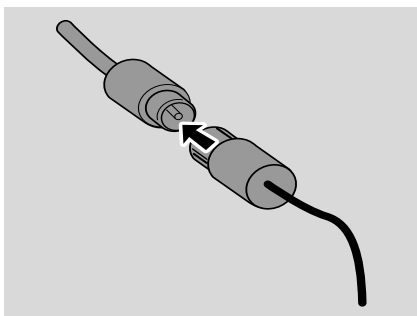

Note: If you are using a cable antenna system or an outdoor antenna, fit the antenna plug, instead of the wire antenna, to FM ANTENNA.

- 2 Move the antenna in different positions for optimal reception (as far away as possible from the TV, VCR or other radiation sources)
- 3 Fix the antenna's end to the wall

Connecting an additional appliance

Connecting a USB device or memory card

By connecting a USB mass storage device (including USB flash memory, USB flash players or memory cards) to the Hi-Fi system, you can enjoy the device's stored music through the powerful speakers of Hi-Fi system.

- 1 Check you have unfolded the control panel

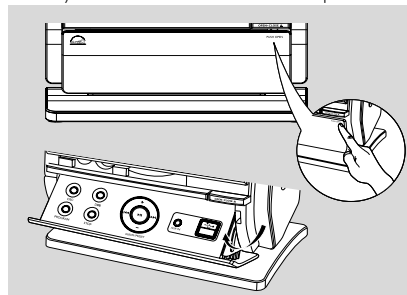

- 2 Insert the USB device's USB plug into the socket  on the set's foldable control panel

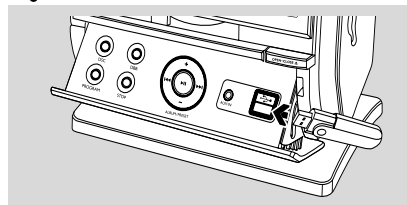

or

for the devices with USB cable:

- a. Insert one plug of the USB cable (not supplied) to the socket  on the set's foldable control panel
- b. Insert the other plug of the USB cable to the USB output terminal of the USB device

or

for the memory card:

- a. Insert the memory card into a card reader (not supplied)
- b. Use a USB cable (not supplied) to connect the card reader to the socket  on the set's foldable control panel

Installation

Connecting a non-USB device

It is possible to use an additional appliance, e.g. TV, VCR or CD recorder with the set. On MCM277, you can playback music from an external source.

- 1 Follow the Step 1 under **Connecting a USB device or memory card**
- 2 Insert one plug of the audio cable (not supplied) to the socket **AUX IN** on the set's foldable control panel
- 3 Connect the other end of the audio cable to the **AUDIO OUT** terminal of the additional appliance

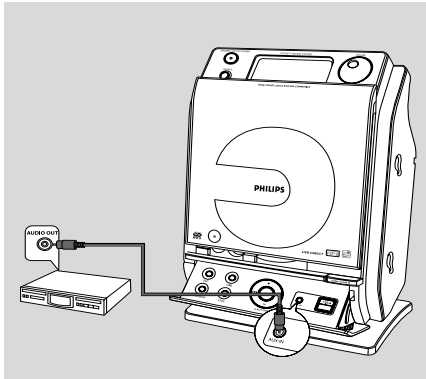

- 4 Select **AUX** mode on the set

Helpful hints:

– Always refer to the owner's manual of other equipment for complete connection.

Using AC power

- 1 Make sure all the connections have been made before switching on the power supply
- 2 Connect the AC power cord to the wall socket. This switches on the power supply

When MCM277 is switched to standby, it is still consuming some power. **To disconnect the system from the power supply completely, remove the power plug from the wall socket.**

The type plate is located on the rear of the set.

For users in the U.K.: please follow the instructions on page 2.

Warning!

To avoid overheating of the system, a safety circuit has been built in. Therefore, your system may switch to Standby mode automatically under extreme conditions. If this happens, let the system cool down before reusing it (not available for all versions).

This product complies with the radio interference requirements of the European Community.

CAUTION

Visible and invisible laser radiation. If the cover is open, do not look at the beam.

High voltage! Do not open. You run the risk of getting an electric shock.

The machine does not contain any user-serviceable parts.

Modification of the product could result in hazardous radiation of EMC or other unsafe operation.

Preparation

Using the remote control

IMPORTANT!

- Remove the protective plastic tab before using the remote control.
- Always point the remote control directly towards IR area.

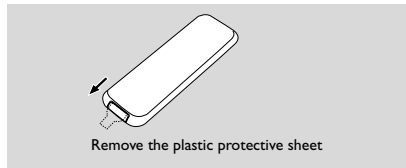

Notes for remote control:

- First select the source you wish to control by pressing one of the source select keys on the remote control (for example CD, TUNER).
- Then select the desired function (for example **▶ II**, **◀◀**, **▶▶**).

To replace the remote controls' battery

- 1 Press and hold **◀** as indicated.
- 2 Simultaneously, pull the battery tray at **▼**.
- 3 Remove the old battery and put a new CR2025 battery in place.
- 4 Put back the battery tray.

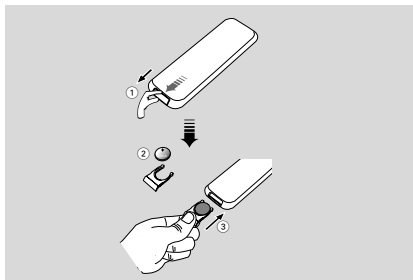

CAUTION!

- Remove the battery if it is exhausted or will not be used for a long time.
- Batteries contain chemical substances, so they should be disposed of properly.
- Danger of explosion if battery is incorrectly replaced. Replace only with the same or equivalent type.

Setting the clock

After connecting MCM277 to the power supply, set the clock first.

- 1 Press and hold **STANDBY-ON/ ECO POWER** to switch the set to Standby mode
 - The display shows the set time
 - -- :-- :-- flashes by default if you have not set the clock
- 2 In the standby mode, press and hold **DISPLAY/ CLOCK** on the remote control
 - SET CLOCK scrolls on the display
 - 24 HR or 12 HR appears for the initial clock setting. **To select 24-hour clock or 12-hour clock,**
 - On the remote control, press **VOL +/-** once or more (or turn **VOLUME** on the set)
 - On the remote control, press **DISPLAY/ CLOCK** to confirm
 - The hours digits start flashing
- 3 Hold down or press **VOL +/-** repeatedly to set the hours (or turn **VOLUME** on the set)
- 4 Press **DISPLAY/CLOCK** to confirm
 - The minutes digits start flashing
- 5 Hold down or press **VOL +/-** repeatedly to set the minutes (or turn **VOLUME** on the set)
- 6 Press **DISPLAY/CLOCK** to confirm
 - To exit without storing the clock setting press **STOP ■**

Helpful hints:

- The clock setting will be erased when the system is disconnected from the power supply.
- The set will exit from the clock setting mode if no button is pressed within 90 seconds.
- To set the clock automatically by using a time signal which is broadcast together with the RDS signal see chapter **RDS: Automatic clock setting via RDS**.



Basic Functions

Switching on/off the set and selecting functions

- 1 To switch on, press **STANDBY-ON/ ECO POWER** or **SOURCE** on the set (or \odot on the remote control)
 - The set switches to the last source selected
- OR**
- On the remote control, press the source button (e.g. **USB, CD, TUNER, AUX**)
- 2 When the set is on, press **STANDBY-ON/ ECO POWER** to switch off (or \odot on the remote control)
- 3 To select your function, press **SOURCE** once or more on the set (or **USB, CD, TUNER, AUX** on the remote control)

Helpful hints:

- You can also switch on the set by pressing **CD OPEN • CLOSE**

Switching between Standby and ECO POWER mode

- 1 When the set is switched off, press and hold **STANDBY-ON/ ECO POWER** to switch between Standby and ECO POWER mode (or \odot on the remote control)
 - In ECO POWER mode** (power-saving mode):
 - **ECO PWR** scrolls on the display
 - The display is switched off
 - The **Red** indicator lights up
 - In Standby mode:** → The clock is displayed

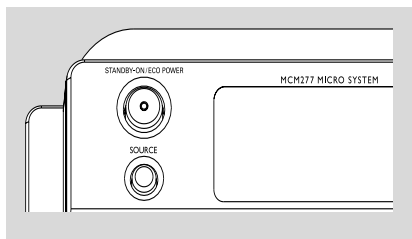

Helpful hints:

- In the standby/Eco power mode, the tone, sound settings, tuner presets and the volume level (up to a maximum volume level of 20) will be retained in the set's memory.

Auto-standby

When the set has reached the end of CD playback and remains in the stop position for more than 15 minutes, the set will switch off automatically to save power.

Volume control

Volume adjustment

- Adjust the volume by using the **VOLUME** rotary on the set or by pressing **VOL +/-** on the remote control
 - **VOL** and the actual value (between 1 and 31) are displayed
 - **VOL MIN** is the minimum volume level
 - **VOL MAX** is the maximum volume level

MUTE

You can temporarily switch off the sound without switching off the set.

- 1 Press **MUTE** on the remote control to switch off the sound
 - **MUTE** appears. Playback continues without sound
- 2 To switch on the sound, you can:
 - press **MUTE** again;
 - adjust the volume controls;
 - change source



Basic Functions

Sound control

DSC

Digital **S**ound **C**ontrol enables you to select predefined sound settings.

- Press **DSC** repeatedly to select the desired sound setting: *ROCK, JAZZ, POP, CLASSIC*

DBB

- Press **DBB** (**D**ynamic **B**ass **B**oost) once or more to switch bass enhancement on or off.
→ **DBB** appears if **DBB** is activated

Displaying the clock

- During playback, press **DISPLAY/CLOCK** on the remote control repeatedly to switch between the clock display and the playback display.

Notes:

- When playing MP3 files, you will get track information (ID3 tag) by pressing **DISPLAY/CLOCK**

Discs for playback

With this system, you can play

- all pre-recorded audio CDs (CDDA)
- all finalized audio CD-Rs and CD-RWs
- MP3/WMA-CDs (CD-Rs/CD-RWs with MP3/WMA files)



IMPORTANT!

- **This system is designed for regular discs. Therefore, do not use any accessories such as disc stabilizer rings or disc treatment sheets, etc.**

About MP3/WMA

The music compression technology MP3 (MPEG1 Audio Layer 3) and WMA (Windows Media Audio) significantly reduces the digital data of an audio CD while maintaining CD quality sound.

Windows Media Audio® is a registered trademark of Microsoft Corporation.

Supported formats:

- Disc format ISO9660, Joliet, UDF (created on Adaptec Direct CD) and multi-session CDs
- MP3 bit rate (data rate): 32-320 Kbps and variable bit rate
- Directory nesting up to a maximum of 8 levels
- Max. track number plus album: 500
- WMA v9 or earlier



The system will not play or support the following:

- Empty albums: an empty album is an album that does not contain MP3/WMA files, and will not be shown in the display.
- Non-supported file formats are skipped. This means that e.g.: Word documents .doc or MP3 files with extension .dlf are ignored and will not be played.
- DRM protected WMA files
- WMA files in Lossless or VBR format

IMPORTANT!

- Make sure that the file names of MP3 files end with .mp3.
- For DRM protected WMA files, use Windows Media Player 10 (or later) for CD burning/ conversion. Visit www.microsoft.com for details about Windows Media Player and WM DRM (Windows Media Digital Rights Management).

Playing discs

- 1 Press **SOURCE** once or more to select **CD** (or **CD** on the remote control)
→ The CD icon  appears
- 2 Press **CD OPEN•CLOSE**  to open the CD compartment.
→ **OPEN** is displayed

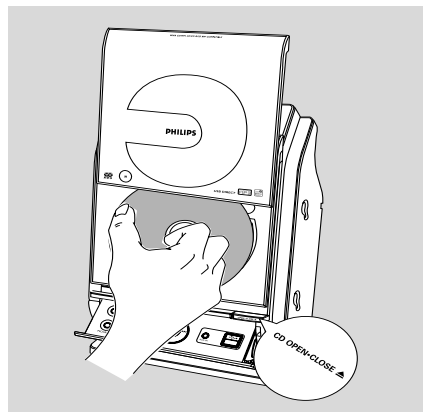

- 3 Insert a disc with the printed side facing up. Press **CD OPEN•CLOSE**  again to close the compartment
→ **READING** is displayed as the CD player scans the contents of a disc
→ **Audio CD**: the total number of tracks and playing time are shown
MP3/WMA: Display shows current album number "A x x" and current track number "T x xx"

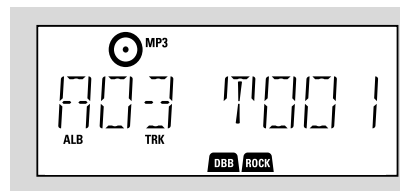

CD

Helpful hints:

– If you have not organized MP3/WMA files into any albums on your disc, an album “00” will be automatically assigned for all those files.

- 4 Press ►|| to start playback
→ Display shows current track number and elapsed playing time

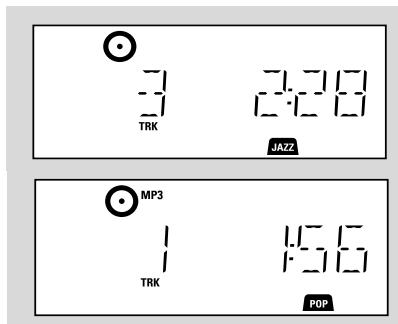

- 5 To pause playback, press ►||. To resume playback, press the button again
- 6 To stop playback, press **STOP** ■

Helpful hints:

CD play will also stop when

- the CD door is opened
- the disc has reached the end
- you select another source: **TUNER, USB** or **AUX**

Selecting and searching

Selecting a different track

- Press ◀◀ / ▶▶ once or repeatedly until the desired track number appears in the display
MP3/WMA: → Track information scrolls briefly

MP3/WMA:

- Press ▲ / ▼ once or more to select the next or previous album
→ Track information scrolls briefly
- or**
- In the stop position, press ▲ / ▼ and ◀◀ / ▶▶ to select the desired album and track
→ **MP3/WMA:** Display shows current album/track number

Finding a passage within a track during playback

- 1 During playback, press and hold ◀◀ / ▶▶
→ The CD plays at a high speed
- 2 When you recognize the passage you want, release ◀◀ or ▶▶
→ Normal playback resumes



CD

English

Programming tracks

You may store up to 40 tracks in the desired sequence. If you like, store any track more than once.

- In the stop position, press **PROG** to start programming
 - **P** flashes
 - **Audio CD**: Display shows *PROG* and current track number
 - **MP3/WMA**: Display shows current album/track number

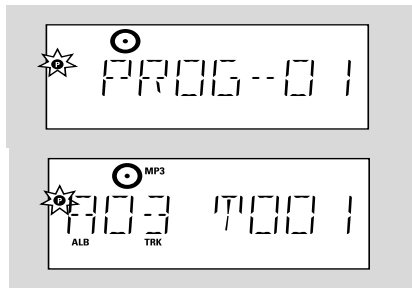

- Press **◀◀ / ▶▶** once or repeatedly until the desired track number appears in the display
- MP3/WMA**: press **▲ / ▼** and **◀◀ / ▶▶** to select the desired album and track
- Press **PROG** to confirm
 - Display shows briefly the number of tracks programmed
 - Then, the display shows the track number you just stored

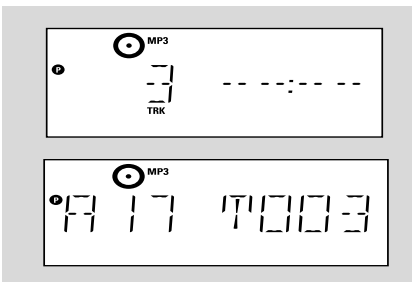

- Repeat steps 2-3 to select and store all desired tracks.
 - *FULL* is displayed if you attempt to program more than 40 tracks
- Press **▶ ||** play the program

Helpful hints:

- The set will return to the stop position if no button is pressed within 90 seconds.
- **P** disappears. To resume programming, press **PROG**.
- **MP3/WMA**: When playing a program, use of **▲ / ▼** are void.

Erasing the program

You can erase the contents of the memory by:

- Press **STOP ■**
 - once if in the stop position;
 - twice during playback;
- Press **STANDBY-ON/ ECO POWER ⏻**
- Select another sound source
- Open the CD door
 - **P** disappears. *CLEAR* scrolls



CD

Different play modes: REPEAT, SHUFFLE

REPEAT TRACK – plays the current track continuously

REPEAT ALL – plays the entire disc/program continuously

SHUFFLE – plays all the tracks in random order

- 1 During playback, press once or more **REPEAT** or **SHUFFLE** to select play modes
- 2 To return to normal playback, press **REPEAT** or **SHUFFLE** repeatedly until the various modes are no longer displayed

Helpful hints:

– In the shuffle mode, press **▶|** to select tracks.

Display track information (MP3/WMA only)

The ID3 tag is part of an MP3/WMA file and contains various track information such as the track's title or the artist's name.

- During playback, press **DISPLAY/CLOCK** repeatedly on the remote control
→ Display show title name, album name and ID3 tag information

Helpful hints:

– **Complete the ID3 tag information with your MP3/WMA encoder software before burning the MP3/WMA-CD.**



Tuner

English

Tuning to radio stations

- 1 Press **SOURCE** once or more to select **TUNER** (or **TUNER** on the remote control)
- 2 Press **TUNER** on the remote control repeatedly to select your desired waveband, FM or MW
→ Display shows:  **TUNER**, radio station frequency, waveband and if programmed, a preset number

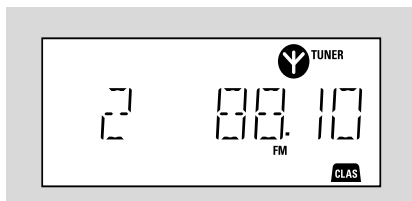

- 3 Press and hold **◀ / ▶** until **SEARCH** appears
→ The radio automatically tunes to a station with sufficient reception. Display shows **SEARCH** during automatic tuning
→ **FM**: If a station is received in stereo, **∞** is shown
→ **FM**: When you are receiving an RDS station, **R·D·S** is shown
- 4 Repeat step 3 if necessary until you find the desired station.
- To tune to a weak station, press **◀ / ▶** briefly and repeatedly until you have found optimal reception.

Programming radio stations

You can store up to a total of 40 radio stations (FM and MW) in the memory, manually or automatically (Autostore).

Autostore: Automatic programming

Automatic programming will start from preset 1 or a chosen preset number. From this preset number upwards, former programmed tuner stations will be erased. The set will only program stations which are not in the memory already.

- 1 Press the **▲ / ▼** buttons once or more to select the preset number where programming should start.

Note:

– If no tuner preset number is selected, default is preset 1 and all your presets will be erased.

- 2 Press and hold **PROG** until **AUTO** appears
→ **P** flashes
→ Available stations are programmed: RDS stations followed by FM stations, MW stations (See **RDS**)
→ After all stations are stored, the last preset station will then be played

Manual programming

- 1 Tune to your desired station (see **Tuning to radio stations**)
- 2 Press **PROG** to activate programming
→ **P** flashes
- 3 Press **▲ / ▼** to allocate a number from 1 to 40 to this station.
- 4 Press **PROG** to confirm
→ Display shows the preset number, waveband and the frequency of the preset station
- 5 Repeat steps 1-4 to store other stations
- You can erase a preset station by storing another frequency in its place

To listen to a preset station

- Press the **▲ / ▼** buttons once or more until the desired preset station is displayed.



Tuner

RDS

The feature RDS (**R**adio **D**ata **S**ystem) is a service that allows FM stations to send additional information along with the regular FM radio signal. When you are receiving an RDS station, **RDS** and the station name are displayed.

Switching through RDS information

- 1 Tune to the desired RDS radio station on the FM waveband (see **Tuning to radio stations**)
- 2 Press **RDS/NEWS** on the remote control repeatedly to switch through the following information (if available):
 - Station name
 - Program type (for example: News, Sport, etc.)
 - Radio text messages
 - Frequency

Note:

– **NO PS**, **NO TYPE** or **NO TEXT** is displayed if you press **RDS/NEWS** and no RDS signal is available.

Tuning to a program type (PTY)

PTY enables you to tune to a desired program type.

- 1 Program RDS stations (See **Programming radio stations**)
- 2 When tuning to an RDS station, press **RDS/NEWS** on the remote control repeatedly until the program type is displayed
- 3 Press **▲ / ▼** repeatedly to select the desired program type
- 4 Press and hold **◀◀ / ▶▶** until **SEARCH** appears
 - The radio tunes to a radio station broadcasting of the program type
 - **TYPE NOT FOUND** is displayed if the program type is not available

Automatic clock setting via RDS

When the set is on, the clock can be automatically set by a time signal broadcast together with the RDS signal. This only works if the RDS station is sending this time signal.

Note:

– The time signal broadcast from certain RDS stations may not always be accurate

RDS News and Traffic Announcement (TA)

While listening to CD, USB or AUX source, you can activate NEWS. The set will tune to the news/traffic announcement if the related signals are received from a RDS station.

Activating the NEWS function

- During playback in **CD**, **USB** or **AUX** source, press **RDS/NEWS** on the remote control
 - **NEWS** appears and **NEWS ON. TA ON** is displayed briefly
 - Playback continues when the set scans for RDS news on the FM band
 - When news transmission is detected, the set will switch to the news/traffic announcement station.
 - After the news is broadcast, the set will switch to the last source selected

Deactivating NEWS

- Press **RDS/NEWS** again on the remote control
 - **NEWS** disappears and **NEWS OFF** is displayed briefly

USB

English

Using a USB mass storage device

By connecting a USB mass storage device to the Hi-Fi system, you can enjoy the device's stored music through the powerful speakers of Hi-Fi system.

Playing a USB mass storage device

Compatible USB mass storage devices

With the Hi-Fi system, you can use

- USB flash memory (USB 2.0 or USB1.1)
- USB flash players (USB 2.0 or USB1.1)
- memory cards (requires an additional card reader to work with this Hi-Fi system)

Note:

- In some USB flash players (or memory devices), the stored contents are recorded using copyright protection technology. Such protected contents will be unplayable on any other devices (such as this Hi-Fi system).

Supported formats:

- USB or memory file format FAT12, FAT16, FAT32 (sector size: 512 - 2,048 bytes)
- MP3 bit rate (data rate): 32-320 Kbps and variable bit rate
- WMA v9 or earlier
- Directory nesting up to a maximum of 8 levels
- Number of albums/ folders: maximum 99
- Number of tracks/titles: maximum 999
- ID3 tag v2.0 or later
- File name in Unicode UTF8 (maximum length: 128 bytes)

The system will not play or support the following:

- Empty albums: an empty album is an album that does not contain MP3/WMA files, and will not be shown in the display.
- Non-supported file formats are skipped. This means that e.g.: Word documents .doc or MP3 files with extension .dlf are ignored and will not be played.
- AAC, WAV, PCM audio files
- DRM protected WMA files
- WMA files in Lossless format

How to transfer music files from PC to a USB mass storage device

By dragging and dropping music files, you can easily transfer your favorite music from PC to a USB mass storage device.

For the flash player, you can also use its music management software for the music transfer:

However, those WMA files may be unplayable for compatibility reasons.

How to organize your MP3/WMA files on the USB mass storage device

This Hi-Fi system will browse the MP3/WMA files in the folders/sub-folders/titles order.

Example:

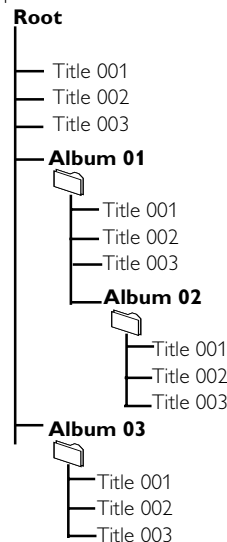

Organize your MP3/WMA files in different folders or subfolders as required.

Note:

- If you have not organized MP3/WMA files into any albums on your disc, an album "00" will be automatically assigned for all those files.
- Make sure that the file names of MP3 files end with .mp3, and the file names of WMA files end with .wma.
- For DRM protected WMA files, use Windows Media Player 10 (or later) for conversion. Visit www.microsoft.com for details about Windows Media Player and WM DRM (Windows Media Digital Rights Management).

USB

- 1 Check the USB device has been properly connected. (See **Installation: Connecting an additional appliance**)
- 2 Press **SOURCE** once or more to select **USB** (or **USB** on the remote control)
→ The icon  **USB DIRECT** appears

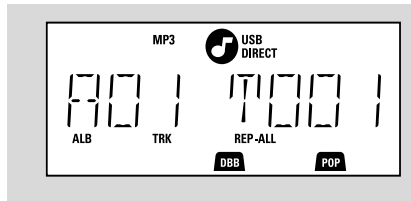

– **NO AUDIO** appears if no audio file is found in the USB device

- 3 Play the USB's audio files as you do with the albums/tracks on a CD (See **CD**)

Note:

- For compatibility reasons, the album/track information may differ from what it is displayed through flash players' music management software.
- File names or ID3 tags will be displayed as — if they are not in English.

AUX

AUX (Listening to an external source)

You can listen to the sound of the connected external device through your MCM277

- 1 Check the external device has been properly connected (See **Installation, Connecting an additional appliance**)
- 2 Press **SOURCE** once or more to select **AUX** (or **AUX** on the remote control)
- 3 To avoid noise distortion, turn down the volume on your external device
- 4 Press the **PLAY** key on the connected device to start playback
- 5 To adjust the sound and volume, use the sound controls on your external device and the MCM277



Timer

SLEEP

English

Setting the timer

The set can be used as an alarm clock, whereby the selected source (CD, TUNER or USB) starts playback at a preset time. **Make sure the clock is set before using the timer.**

- 1 Press and hold **TIMER** on the remote control until **SET TIMER** appears
 -  flashes. **SELECT SOURCE** scrolls
 - Display shows current source: **CD**, **TUNER** or **USB**
- 2 Press **SOURCE** on the set repeatedly to select the source (or press **CD**, **TUNER** or **USB** on the remote control)
- 3 Press **TIMER** to confirm
 - The hours digits start flashing

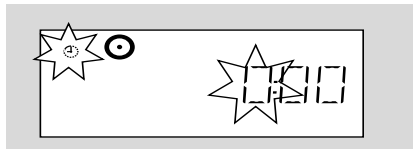

- 4 Hold down or press **VOL +/-** repeatedly to set the hours (or turn **VOLUME** on the set)
- 5 Press **TIMER** to confirm
 - The minutes digits start flashing
- 6 Hold down or press **VOL +/-** repeatedly to set the minutes (or turn **VOLUME** on the set)
- 7 Press **TIMER** to confirm
 - The timer is now set and activated
 - At the set alarm time, the CD, TUNER or USB will switch on (volume level: max. 20)

Note:

- The set will exit from the timer setting mode if no button is pressed within 90 seconds.

Activating and deactivating TIMER

- Press **TIMER** on the remote repeatedly to activate or deactivate the timer.
 - If activated, the last set source and start time are displayed
 - If deactivated, "TIMER OFF" appears

Helpful hints:

The timer will not work at the set time if

- the set is switched on
- the timer is deactivated

The set will switch to Tuner source automatically if:

- no CD is inserted when the selected source is CD;
- no USB device is connected when the selected source is USB

SLEEP

You can set a certain period of time after which the set will switch off.

- On the remote control, press **SLEEP** repeatedly to select the desired time period options (in minutes):
 - Display shows in sequence: **Sleep 90, 75, 60, 45, 30, 15**
 - Display shows the selected option briefly and returns to its previous status. The icon **zzZ** appears

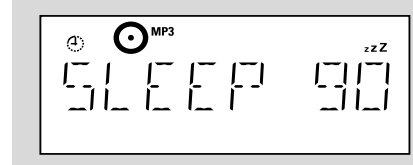

To deactivate the sleep timer, press **SLEEP** again

- The icon **zzZ** disappears

or

Press **STANDBY-ON/ ECO POWER** to switch off the set (or  on the remote control)

Helpful hints:

- The SLEEP function does not affect your alarm time setting.



Specifications

AMPLIFIER

Output power	2 x 5 W RMS
.....	10 W + 10 W MPO
Signal-to-noise ratio	≥ 75 dBA
Frequency response	50 – 20,000 Hz, ± 3 dB
Input sensitivity AUX	0.5 V (max. 2 V)
Impedance loudspeakers	≥ 4 Ω
Impedance headphones	32 Ω -1000 Ω
.....	<0.5W

CD PLAYER

Frequency range	30 – 18000 Hz
Signal-to-noise ratio	75 dBA

TUNER

FM wave range	87.5 – 108 MHz
MW wave range	531 – 1602 kHz
Number of presets	40
Antenna	
FM	75 Ω wire
MW	Loop antenna

USB PLAYER

USB	12Mb/s,V1.1
.....	support MP3 and WMA files
Number of albums/ folders	maximum 99
Number of tracks/titles	maximum 999

SPEAKERS

Bass reflex system	
Dimensions (w x h x d)	160 x 269 x 90 (mm)

GENERAL INFORMATION

AC Power	220 – 240V / 50 Hz
Dimensions (w x h x d, with/without the stand)	
.....	194 x 285 x 118/194 x 269 x 90 (mm)
Weight(with/without speakers)	3.8 / 2.2 kg
Standby power consumption	<5 W
Eco power standby	<0.5 W

Specifications and external appearance are subject to change without notice.

Maintenance

Cleaning the Cabinet

- Use a soft cloth slightly moistened with a mild detergent solution. Do not use a solution containing alcohol, spirits, ammonia or abrasives.

Cleaning Discs

- When a disc becomes dirty, clean it with a cleaning cloth. Wipe the disc from the centre out.
- Do not use solvents such as benzene, thinner, commercially available cleaners, or antistatic spray intended for analogue records.

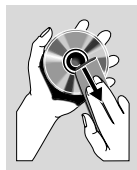

Cleaning the disc lens

- After prolonged use, dirt or dust may accumulate at the disc lens. To ensure good playback quality, clean the disc lens with Philips CD Lens Cleaner or any commercially available cleaner. Follow the instructions supplied with cleaner.

Troubleshooting

WARNING

Under no circumstances should you try to repair the system yourself, as this will invalidate the warranty. Do not open the system as there is a risk of electric shock.

If a fault occurs, first check the points listed below before taking the system for repair. If you are unable to remedy a problem by following these hints, consult your dealer or Philips for help.

English

Problem	Solution
"NO DISC" is displayed.	<ul style="list-style-type: none">✓ Insert a disc.✓ Wait until the moisture condensation at the lens has cleared.✓ Replace or clean the disc, see "Maintenance".✓ Use a finalised CD-RW or a correct MP3/WMA-CD format disc.
Some files on the USB device are not displayed.	<ul style="list-style-type: none">✓ Check if the number of folders exceeds 99 or the number of titles exceeds 999
Radio reception is poor.	<ul style="list-style-type: none">✓ If the signal is too weak, adjust the antenna or connect an external antenna for better reception.✓ Increase the distance between the Micro HiFi System and your TV or VCR.
The system does not react when buttons are pressed.	<ul style="list-style-type: none">✓ Remove and reconnect the AC power plug and switch on the system again.
Sound cannot be heard or is of poor quality.	<ul style="list-style-type: none">✓ Adjust the volume.✓ Disconnect the headphones.✓ Check that the speakers are connected correctly.✓ Check if the stripped speaker wire is clamped.✓ Make sure the MP3-CD was recorded within 32~256 kbps bit rate with sampling frequencies at 48 kHz, 44.1 kHz or 32 kHz.
The left and right sound outputs are reversed.	<ul style="list-style-type: none">✓ Check the speaker connections and location.

27

Troubleshooting

The remote control does not function properly.

- ✓ Select the source (CD or TUNER, for example) before pressing the function button (▶||◀◀, ▶▶).
- ✓ Reduce the distance between the remote control and the system.
- ✓ Insert the battery with its polarities (+/- signs) aligned as indicated.
- ✓ Replace the battery.
- ✓ Point the remote control directly toward IR sensor on the front of the system.

The timer is not working.

- ✓ Check the set is switched off
- ✓ Set the clock correctly.
- ✓ Press TIMER to switch on the timer.

The Clock/Timer setting is erased.

- ✓ Power has been interrupted or the power cord has been disconnected. Reset the clock/timer.

Appendix

English

How to mount your MCM277 onto walls

IMPORTANT!

- The wall mounting instructions are for the use of the qualified wall mounting person only!
- Ask a qualified person to help you with the wall mounting, which includes drilling holes on the wall and mounting the set onto walls.

What's in the supplied mounting kits

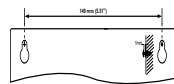

1 x template
(Wall mounting instructions)



2 x screws

What else you'll need

- Drilling tools (e.g. electric drill)

Preparation

- 1 To find a suitable location for mounting, try your necessary rear connections (see the chapter **Installation**).
- 2 Ask a qualified person to help you with the wall mounting, who should:
 - to avoid unexpected damage, learn about the piping, wiring and other relevant information inside your walls;
 - according to the drilling requirements, choose suitable drilling tools;
 - take other precautions necessary for the wall mounting work.

Mounting your MCM277

- 1 Align the template in the chosen location on a wall. Use a pencil to mark the drilling positions (as shown)

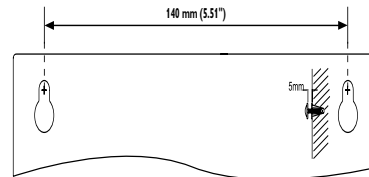

- 2 Drill two 6mm diameter holes as marked
- 3 Secure the dowels and screws in the holes respectively, leaving the screws 5mm proud of the wall

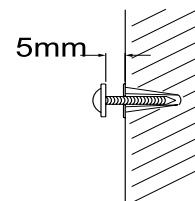

- 4 To detach the stand,
 - a. As shown, hold down the **▲ PRESS** buttons
 - b. Move out the stand to detach

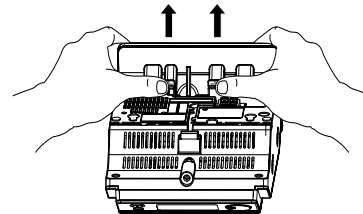

- 5 Hang the unit on the fastening screws
- 6 As shown, hook and mount the speakers in place

