

Tyko

Spotlight
Kohdevalaisin
Spot



Art.no. Model
36-5276 S14653

north
■■■■■ LIGHT

Ver. 20130514

ENGLISH

SVENSKA

NORSK

SUOMI

DEUTSCH

Tyko Spotlight

Art.no 36-5276 Model S14653

Please read the entire instruction manual before using the product and then save it for future reference. We reserve the right for any errors in text or images and any necessary changes made to technical data. If you have any questions regarding technical problems please contact our Customer Services.

All light fittings must be installed in accordance with current safety regulations to prevent life-threatening accidents. The installation of this light fitting should only be performed by someone with a good knowledge of electrical wiring. If unsure, contact a qualified electrician. Follow the instructions carefully and keep them for future reference.

Installation

1. **Warning!** Before beginning any electrical installation always disconnect the power to the circuit you are working on by isolating or removing the fuse in the consumer unit.

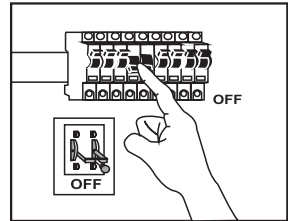

2. Start by fitting the ceiling bracket onto the ceiling by drilling holes 60 mm apart. **Note:** Make sure that there are no hidden cables or water pipes in the ceiling before drilling holes.

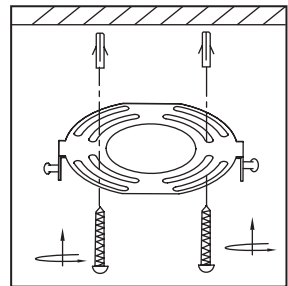

3. Connect the power cable wires as shown in the diagram.
 - Brown or black (Live) to L.
 - Green & Yellow (Earth) to \perp .
 - Blue (Neutral) to N.
 If there is no earth wire, the earth terminal should be left empty.

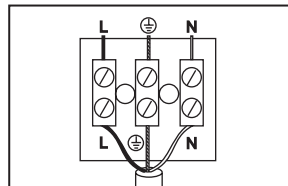

4. Feed the power cable out through the cut-out in the side of the ceiling cup and fasten the ceiling cup to the ceiling bracket using the two side screws.

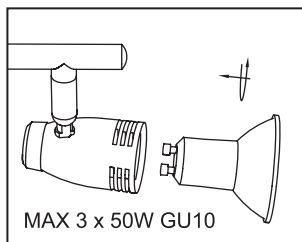
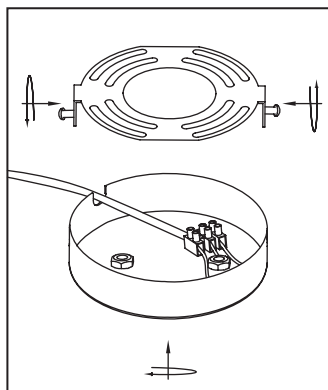

5. Fit light bulbs into the spotlights (3 x 50 W, GU10).

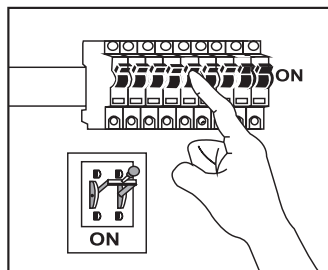

6. Turn the power on.

Specifications

Model	S14653
Voltage	220–240 V AC, 50 Hz
Light bulb	Max 3 x 50 W, GU10
Protection class	IP20 (only for indoor use)
Min distance	Minimum 0.5 m to the illuminated surface

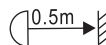

Spotlight Tyko

Art.nr 36-5276 Modell S14653

Läs igenom hela bruksanvisningen före användning och spara den sedan för framtida bruk. Vi reserverar oss för ev. text- och bildfel samt ändringar av tekniska data. Vid tekniska problem eller andra frågor, kontakta vår kundtjänst (se adressuppgifter på baksidan).

Alla belysningsarmaturer måste installeras korrekt för att inte utgöra livsfara. Endast personer med nödvändig kunskap om elinstallationer ska utföra denna installation. Saknas denna kunskap, kontakta fackman. Följ bruksanvisningen noggrant och spara den för framtida bruk.

Installation

1. **Varning!** Före installation, bryt strömmen i den ledning du ska ansluta till antingen med huvudströmbrytare eller genom att ta bort säkringen i elcentralen.

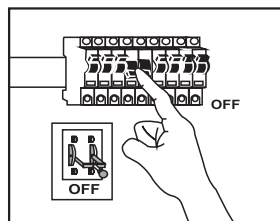

2. Börja med att installera takfästet genom att borra hål på lämplig plats i taket (c/c 60 mm).
Obs! Kontrollera att det inte finns elkablar, vattenledningar eller liknande i taket innan borrhning påbörjas.

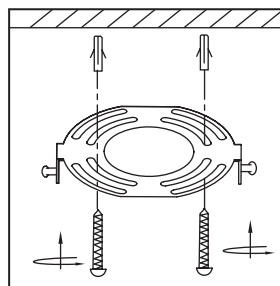

3. Koppla inkommande kabel enligt bild.
 - Brun eller svart (fas) till L.
 - Gulgrön (jordledare) till \perp .
 - Blå (nolledare) till N.

Om jordledning saknas ska plinten till jordledningen lämnas tom.

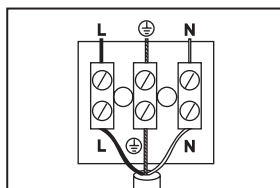

4. Dra ut inkommande kabel på sidan av takkoppen och skruva fast takkoppen på takfästet med de två sidoskruvarna.

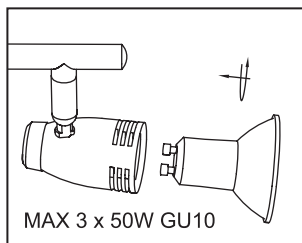
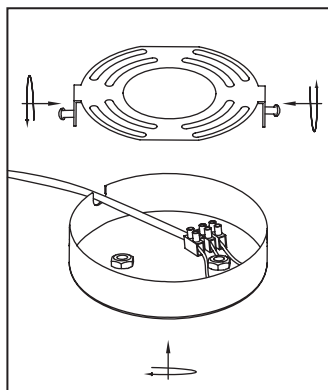

5. Sätt i ljuskällorna (3 x 50 W, GU10).

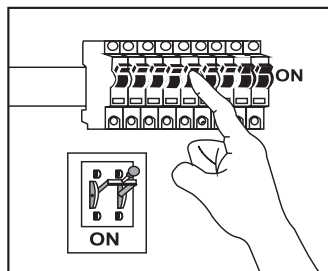

6. Slå på strömmen.

Specifikationer

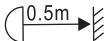
Modell	S14653
Spänning	220–240 V AC, 50 Hz
Ljuskälla	Max 3 x 50 W, GU10
Kapslingsklass	IP20 (endast för inomhusbruk)
Min. avstånd	Minimum 0,5 m till belyst yta 



Spotlight Tyko

Art.nr. 36-5276 Modell S14653

Les brukerveiledningen grundig før produktet tas i bruk og ta vare på den for framtidig bruk. Vi reserverer oss mot ev. feil i tekst og bilde, samt forandringer av tekniske data. Ved tekniske problemer eller spørsmål, ta kontakt med vårt kundesenter. (Se opplysninger om kundesenteret i denne bruksanvisningen).

Alle lysarmaturer må installeres riktig for ikke å være til fare for liv og helse. Denne installasjonen skal kun utføres av personer med nødvendig informasjon om einstallasjoner. Hvis denne kunnskapen mangler, ta kontakt med en fagperson. Les hele bruksanvisningen og ta vare på den for framtidig bruk.

Installasjon

1. **Advarsel!** Før installasjon, bryt strømmen i den ledningen du skal koble til, enten med hovedstrømbryteren eller ved å fjerne sikringen i sikringskasset.

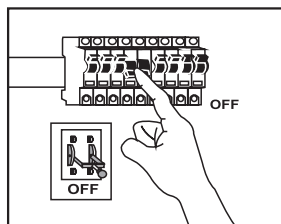

2. Start med montering av takfestet ved å bore hull på ønsket plass i taket (c/c 60 mm).
Obs! Kontroller at det ikke er kabler, vannrør eller liknende i taket før du starter boringen.

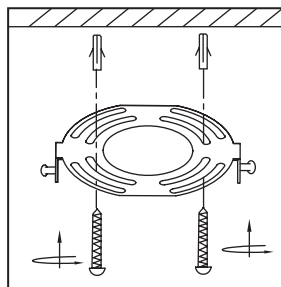

3. Kablene kobles i henhold til bildet.
 - Gul/grønn (jordleder) til \perp .Dersom jordledningen mangler skal plinten til jordledningen være tom.

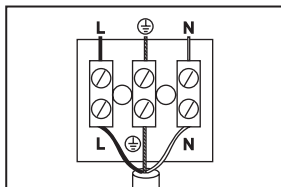

4. Trekk den innkommende kablen ut på siden av takkoppen og skru takkoppen fast til takfestet med de to sideskruene.

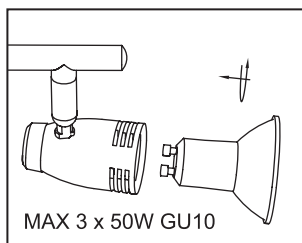
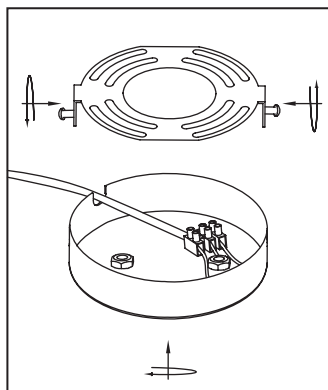

5. Sett i lyskilden (3 x 50 W, GU10).

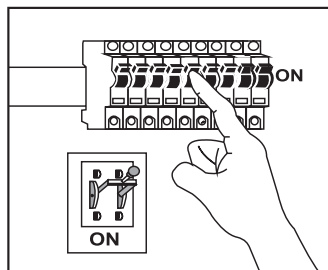

6. Skru på strømmen.

Spesifikasjoner

Modell	S14653
Spenning	220–240 V AC, 50 Hz
Lyskilde	Maks 3 x 50 W, GU10
Kapslingsklasse	IP20 (kun til innendørs bruk)
Min. avstand	Til belyst flate min. 0,5 meter

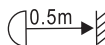

Kohdevalaisin Tyko

Tuotenumero 36-5276 Malli S14653

Lue käyttöohjeet ennen tuotteen käyttöönottoa ja säilytä ne tulevaa tarvetta varten. Pidätämme oikeuden teknisten tietojen muutoksiin. Emme vastaa mahdollisista teksti- tai kuvavirheistä. Jos laitteeseen tulee teknisiä ongelmia, ota yhteys myymälään tai asiakaspalveluun (yhteystiedot käyttöohjeen lopussa).

Kaikki valaisimet tulee asentaa asianmukaisesti, tai ne saattavat aiheuttaa hengenvaaran. Valaisimia saavat asentaa ainoastaan henkilöt, joilla on riittävät taidot sähköasennuksien tekemiseen. Jos sinulla ei ole riittäviä taitoja, ota yhteyttä ammattilaiseen. Noudata käyttöohjeita tarkasti ja säilytä ne tulevaa tarvetta varten.

Asennus

1. **Varoitus!** Sammuta liitettävän kaapelin virta ennen asentamista joko päävirtakytkimestä tai irrottamalla sulake sähkökaapista.

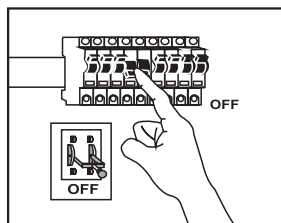

2. Aloita kattokiinnikkeen asentaminen poraamalla kattoon reiät sopivaan kohtaan (reikien etäisyys 60 mm). **Huom.!** Tarkista ennen poraamisen aloittamista, että katossa ei ole sähkökaapeleita, vesiputkia tai vastaavia.

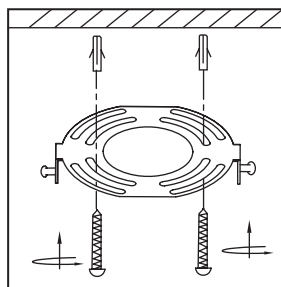

3. Kytke sisääntuleva kaapeli kuvan mukaisesti.
 - Liitä ruskea tai musta johto (vaihejohdin) L-kirjaimella merkittyyn liitäntään.
 - Liitä keltavihreä johto (maajohdin) merkillä \perp merkittyyn liitäntään.
 - Liitä sininen johto (nollajohdin) N-kirjaimella merkittyyn liitäntään.

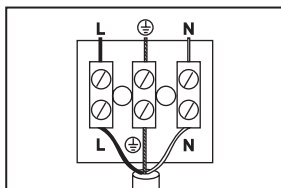

Jos maajohdinta ei ole, jätä maajohtimen liitin tyhjäksi.

4. Vedä sisääntulevaa kaapelia varovasti ulos kattokupin sivulta ja kiinnitä kattokuppi kattokiinnikkeeseen kahdella sivuruuvilla.

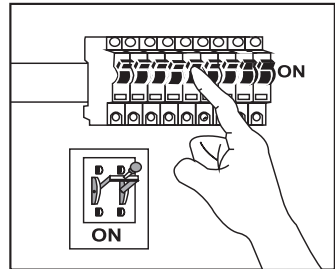
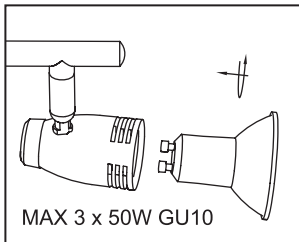
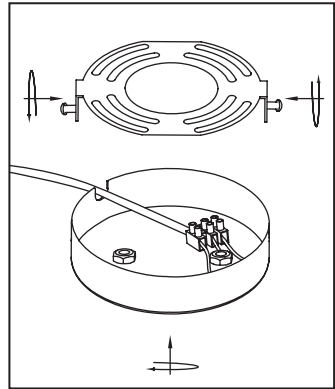

5. Aseta lamput paikalleen (3 x 50 W GU10). 6. Laita sähkövirta takaisin päälle.

Tekniset tiedot

Malli	S14653
Jännite	220–240 V AC, 50 Hz
Valonlähde	Enint. 3 x 50 W, GU10
Kotelointiluokka	IP20 (vain sisäkäyttöön)
Pienin etäisyys	Vähintään 0,5 m valaistuun pintaan

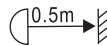

Spot Tyko, Northlight

Art.Nr. 36-5276 Modell S14653

Vor Inbetriebnahme die komplette Bedienungsanleitung durchlesen und aufbewahren. Irrtümer, Abweichungen und Änderungen behalten wir uns vor. Bei technischen Problemen oder anderen Fragen freut sich unser Kundenservice über eine Kontaktaufnahme (Kontakt siehe Rückseite).

Wand- und Deckenleuchten müssen korrekt installiert sein um keine Gefahr auszumachen. Solche Installationen sind nur von Personen mit ausreichenden Kenntnissen über Elektroinstallationen durchzuführen. Sind die Kenntnisse nicht ausreichend muss ein Fachmann konsultiert werden. Die Bedienungsanleitung vollständig durchlesen und für künftigen Gebrauch aufbewahren.

Installation

1. **Warnung:** Vor der Installation den Strom der Leitung abstellen, an welcher die Beleuchtung angeschlossen werden soll.

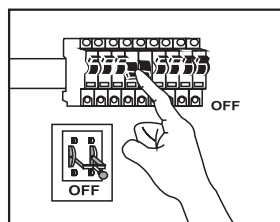

2. Zuerst die Deckenhalterung anbringen. Dazu an geeigneter Stelle die Löcher bohren (60 mm Mittenabstand). **Hinweis:** Vor dem Bohren sicherstellen, dass an dieser Stelle keine Stromleitungen, Wasserrohre o. ä. in der Decke sind.

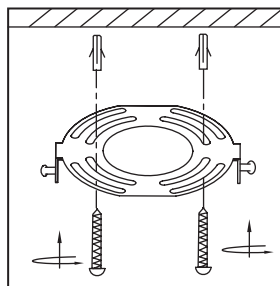

3. Die Stromleitung wie im Bild anschließen.
 - Braun bzw. schwarz (Phase) an L.
 - Grün-gelb (Schutzleiter) an \perp .
 - Blau (Neutralleiter) an N.

Wenn kein Schutzleiter vorhanden ist, ist die Klemme dafür frei zu lassen.

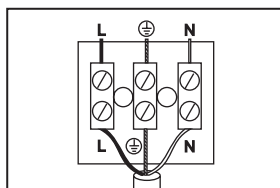

4. Die Stromleitung an der Seite der Deckendose herausziehen und die Deckendose an der Deckenhalterung mit den zwei Seitenschrauben festschrauben.

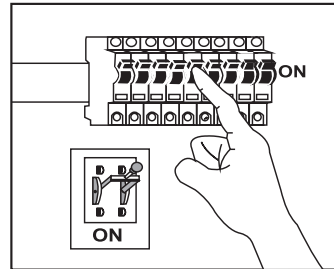
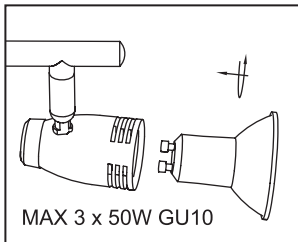
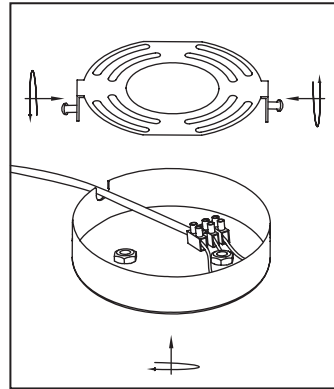

5. Leuchtmittel einsetzen (3 × 50 W, GU10). 6. Den Strom einschalten.

Technische Daten

Modell	S14653
Betriebsspannung	220–240 V AC, 50 Hz
Leuchtmittel	Max. 3 × 50 W, GU10
Schutzart	IP20 (nur für den Innenbereich geeignet)
Min. Abstand	Minimum 0,5 m zu beleuchteter Oberfläche

